

Auhagen



NEW ITEMS 2021

KITS AND ACCESSORIES FOR MODEL RAILWAYS H0 · TT · N

DIVERSITY, QUALITY, DETAILED LIFE.

Tradition
seit
1885

WWW.AUHAGEN.DE

11 462

B-A-U
KASTEN
System

11 462 H0 Railroad maintenance with ramp



The Railroad maintenance provides office and recreational space for the track inspector, trackwalkers and railway workers. It also houses the materials and tools required for daily maintenance of a particular section of track. The model consists of offices and a garage. Small vehicles can be parked under the lean-to roof at the rear. The pole rack can be used to store items such as new posts for signal boards. Vehicles can be loaded onto flat cars via an end-loading ramp constructed of old sleepers.

Available from 03/2021

172 x 150 x 74 mm / 112 x 30 x 20 mm

41 669 H0 Multicar M22, Railroad maintenance

The Multicar M22 with hoop cover is a good addition to the railroad maintenance. With its orange colouring and the DR logo printed on the door, as well as the inscription "Bahnmeisterei", it is ready to transport anything. In our case, it is bringing hot food to the railway construction site in food pails (included).

Available from 03/2021

39 x 15 x 25 mm

11 462

B-A-U
KASTEN
System

11 462

B-A-U
KASTEN
System

41 669



41 669



41 669



41 668



**41 668 H0
Loader T172,
Railroad maintenance**

The T172 was built from 1961 to 1967. A further development of the T170, it came with a 17 HP motor, two-speed gearbox, a new hydraulically operated boom constructed of sheet metal and dual tyres on the rear axle. The delicate, intricately printed kit conveys the ideal of a track inspector's house. A steerable front axle, the ability to rotate 360° and a variable-angle boom that can be fitted with a hook, rake grapple or clamshell bucket make it possible to create all kinds of authentic scenes. It can even be loaded onto a flat car, using the included single tyres on the drive axle.
Available from 03/2021

41 668



41 668

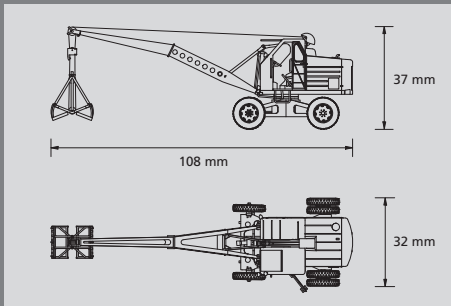

**41 670 H0
Railway construction set**

The railway construction set, with its extensive assortment of tools and materials, is the perfect addition to the track inspector's house. The small crew car transports the power generator and distributor for the two spike drivers. A delicate electric screwdriver, two rack-and-pinion jacks, rail and sleeper tongs, socket spanners, fishplate spanners and crowbars round off the kit. The included standard sleeper screws, railway tie plates, fishplates and individual wooden sleepers help to create more realistic railway construction scenes. Two safety signal boards can be mounted on the track to ensure the necessary safety.
Available from 03/2021

41 670



Hand pattern model

41 670



41 670



41 670



11 463 H0
Schmidt Street 31/33



The Schmidt Street buildings have been a staple of many model train sets for years. Now the street is getting another extension. A suggestion from an Auhagen seminar attendee prompted the creation of a building with a shoe store. The interior of the store and the curved show windows of the entrance are real eye-catchers, and the grey roof provides a bit of variety in Schmidt Street. The second building is being rehabilitated. The window panes are painted with white crosses for safety, to show that the panes are in there! Carpenters are working on the roof truss, while material is being hoisted up to them by cable. The kit includes a number of construction accessories: wood pile, brackets, windows, all manner of tools and a gravel chute made of thick timber planks. Warning triangles are printed on the construction trailer model.

Available from 09/2021

77 x 88 x 182 mm / 77 x 80 x 228 mm

11 463



11 463



Hand pattern model

11 463



11 463



11 463



11 464



11 464 H0
Schmidt Street 35/37



These two new buildings extend Schmidt Street and turn it into a real promenade that invites people to window shop. The inclusion of a whisky shop in one of the buildings is no accident. Here as well, the idea came from seminar attendees, who in this case were also whisky connoisseurs. Tobacco products make a fitting complement to the spirits on offer. The roof is decked with steel plates. The neighbouring building still shows war damage, with the two upper floors missing and a temporary flat roof. An interesting feature is the tall chimney, held up by a metal frame and supports. The ground floor serves as a receiving area for secondary raw materials. Available from 09/2021

77 x 88 x 153 mm / 77 x 88 x 213 mm

11 464

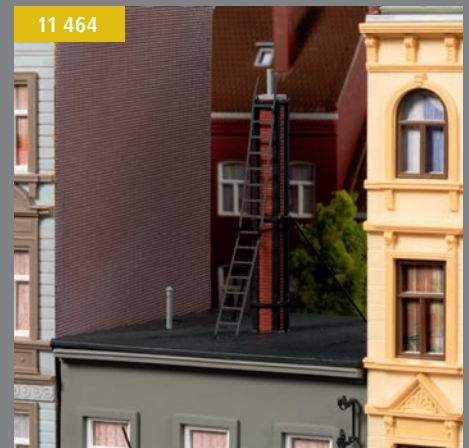

11 464



11 464



11 464



41 671 H0
Tables, chairs

The assortment of chairs and tables is perfect for celebrations with lots of guests. Four chairs fit at each square and rectangular table, and they are stackable for compact storage. Ideal for creating vivid scenes from everyday life.
10 tables and 40 chairs
Available from 09/2021

41 671



13 347



13 347 TT
Railwayman's house
with side building



The residence for a railwayman and his family has a Saxon design, but would be at home in many regions of Germany. The living spaces on the ground floor are small, and the rooms under the roof are very low. One gable wall of the house is clad with grey slate. The side building is used for office and business space. The signal bell, which sounds when the trains pass, gives the whole ensemble an added touch of realism. Authentic historical model
Available from 07/2021

60 x 63 x 54 mm / 58 x 32 x 40 mm

13 347



13 347



13 347



43 673



43 673 TT
Multicar M24-0 with
box body

The M24-0, successor to the Multicar M22, was manufactured by VEB Fahrzeugwerk Waltershausen from 1974. With significantly more power (45 HP), the small truck could reach speeds of 50 km/h. At first only available with a driver seat, the M24-0 got a passenger seat in 1977. Many superstructures were developed for the vehicle, including a rotating ladder, a dump body, a flat bed with loading aid and many more. The finely detailed and printed model is fitted with a box body. Authentic historical model
Available from 07/2021

43 672



Hand pattern model

43 672



43 672



43 672 TT
Multicar M22 dump truck

The TT Multicar M22 fleet is expanding. The dump truck is designed as a rear dumper for the transport of bulk goods such as gravel. The vehicle model is thus once again perfect for creating construction site scenes. Air intake and lights are printed. Authentic historical model
Available from 07/2021

28 x 11 x 16 mm

43 671



ALREADY
in stock
10/2020

43 671 TT
Multicar M22
with waste collection tank

Various versions of the Multicar M22 were made by VEB Fahrzeugwerk Waltershausen between 1964 and 1974. This design was primarily used to dispose of small amounts of waste, for example from waste bins. With realistic tyres, mirrors and trailer coupling. The filling hatches can be depicted as open or closed.
Available from 10/2020

28 x 11 x 16 mm

43 671



ALREADY
in stock
10/2020

43 671



ALREADY
in stock
10/2020

14 487



14 487 N Wagon weighbridge

Wagon weighbridges are used to weigh individual goods wagons. They are usually installed and permanently integrated near loading sidings. Goods wagons are generally weighed before and after loading and unloading. The difference between the measurements is then the weight of the load. The model for N tracks without a built-in trackbed features a scale house made of corrugated sheet metal, which can be heated on cold days.

Available from 09/2021

14 487



14 487

Hand pattern model

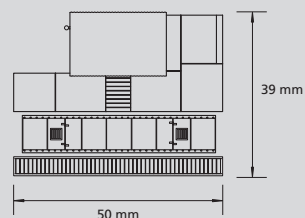

44 656



Hand pattern model

44 656



44 656 N Multicar M22 dump truck and flat bed

The reliable and versatile Multicar M22 small truck is now also available in N scale and as a double pack. Despite their small size, the vehicle models are intricately detailed. Both versions come in various colours and are equipped with a loading bed and a dump body. The lights and air intake are printed.

Available from 09/2021

Each 21 x 8 x 12 mm

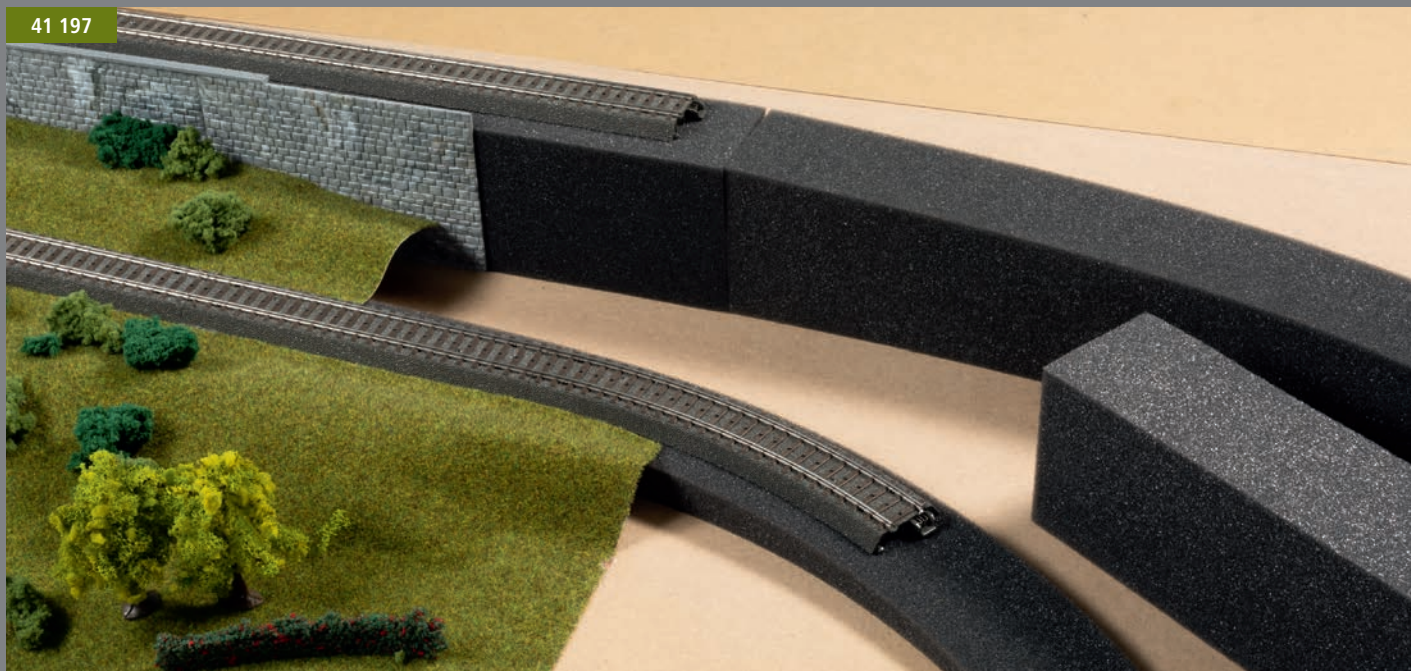

41 197



41 197



43 584

44 598

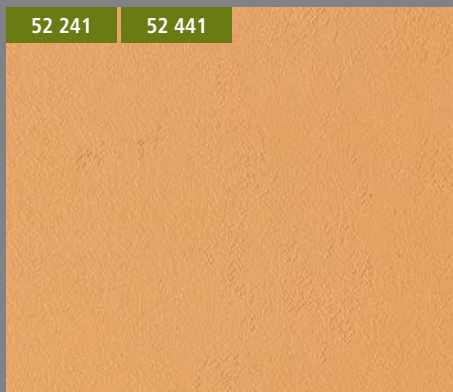

52 241

52 441

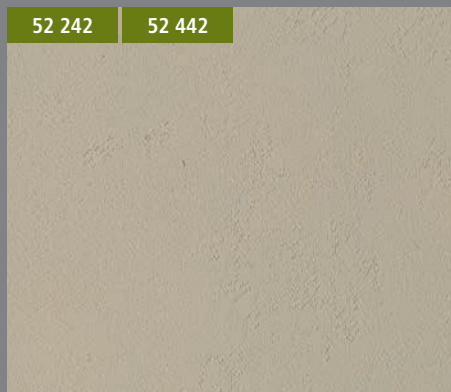

52 242

52 442

**H0/TT/N
Embankment extension –
Foam**

The perfect extension for railway embankment ramp – Foam No. 41 198, 43 585 and 44 599. The material is flexible, light as a feather and can be shaped to any track radius. It also provides reliable dampening of driving noises.

41 197 H0
4 pieces, each 400 x 60 x 80 mm
Available from 09/2021

43 584 TT
4 pieces, each 350 x 40 x 55 mm
Available from 07/2021

44 598 N
4 pieces, each 300 x 30 x 50 mm
Available from 09/2021

**H0/TT
Stucco yellow**

Made of stong polystyrene, finely detailed, for dozens of uses. All wall and accessory sheets are shown actual size (section). Colours may vary with each batch.

52 241 2 pieces
52 441 12 pieces

Available from 07/2021

Each 100 x 200 mm

**H0/TT
Stucco grey**

Made of stong polystyrene, finely detailed, for dozens of uses. All wall and accessory sheets are shown actual size (section). Colours may vary with each batch.

52 241 2 pieces
52 441 12 pieces

Available from 07/2021

Each 100 x 200 mm



Modelling paints

Our modelling paints can be thinned with water, provide excellent cover, and are well suited for designing the ground surface, such as before the application of grass fibres. They can also be used to paint rocks, paths and roads, with practically no odour when working.

Available from 10/2020

78 101

ALREADY
in stock
10/2020



78 101
Signal black

100 ml

78 102

ALREADY
in stock
10/2020



78 102
Pure white

100 ml

78 103

ALREADY
in stock
10/2020



78 103
Grass green

100 ml

78 104

ALREADY
in stock
10/2020



78 104
Clay brown

100 ml

78 105

ALREADY
in stock
10/2020



78 105
Ochre yellow

100 ml

78 106

ALREADY
in stock
10/2020



78 106
Papyrus white

100 ml

78 107

ALREADY
in stock
10/2020



78 107
Graphite gray

100 ml



ALREADY
in stock
10/2020

78 201 Priming brush 25 mm

The 25 mm priming brush is ideal for applying base coats to filler or Auhagen lightweight foam. The width and shape are chosen so that you can even use it between tracks and in hard-to-reach areas.

Available from 10/2020

78 201

ALREADY
in stock
10/2020





78 301

ALREADY
in stock
10/2020



78 302

ALREADY
in stock
12/2020



78 301
Landscaping panels

This very lightweight foam is ideal for modelling. It is easy to work with and resistant to heat, so it is also very good for working with hot glue. Our modelling tool No. 78 501 is suitable for modelling rocks.

2 panels 500 x 250 x 20 mm
2 panels 500 x 250 x 50 mm
1 panel 500 x 250 x 100 mm
Available from 10/2020



78 302
Landscaping card

When building a model, it is often necessary to compensate for different heights of platforms, bridges and crossings, etc., and card is well suited to the job. The card sections are glued with UHU universal adhesive No. 53 514 or White glue No. 53 521.

Thicknesses: 0.5 mm, 1.0 mm, 1.5 mm, 2.0 mm, 3.0 mm
2 sheets of each, 594 x 420 mm
Available from 12/2020

78 300

ALREADY
in stock
10/2020



78 300
Landscaping panels – test set

Landscaping panels and modelling tools for creating a small diorama or area for your model railway system. This very lightweight foam is ideal for modelling. It is easy to work with and resistant to heat, so it is also very good for working with hot glue. The Auhagen modelling tool for working with the panels is enclosed. Modelling set No. 78 500 works well with this.

2 panels 155 x 250 x 20 mm
1 panel 155 x 250 x 50 mm
Available from 10/2020

78 501

ALREADY
in stock
10/2020



78 501
Modelling tool

Two plastic tools specially developed by Auhagen for creating landscapes. The spatula is ideal for stirring and spreading filler. The ingenious scraper can be used to form irregular structures from Auhagen Landscaping panels No. 78 301. Your creativity will find no limits!

Both tools are made of high quality plastic.
Available from 10/2020

78 500

ALREADY
in stock
10/2020



78 500
Modelling set

The perfect complement for our landscaping panels No. 78 300 and No. 78 301, or simply a value-for-money set for day-to-day modelling. The set consists of various materials and tools for designing landscape elements, such as rocks, hills, valleys, paths and roads. Our own filling compound for sculpting landscapes can be tinted with our modelling paints.

White glue 250 ml
Natural sand 800g
Mixing beaker
Modelling tool
Available from 10/2020



90 001

ALREADY
in stock
10/2020



90 001 Cutting mat

The Auhagen cutting mat is ideal for working with cutting knives No. 90 003 or modelling knives, No. 90 005. Its structure of three different solid layers makes the mat practically indestructible. The surface "heals" after each cut, so when you make the next cut, the cutting tool does not slip into an old groove and cause an untidy cut.

The centimetre-spaced square grid printed on the mat makes it easier to lay out components and to trim to recurrent dimensions. The dimensions of the mat mean it is large enough to be able to work comfortably.

The cutting mat is suitable for cutting paper and card, as well as Auhagen plastic panels. It is also an ideal base when trimming sprue from small parts with the cutting knife.

Available from 10/2020

450 x 300 mm

90 002

ALREADY
in stock
10/2020



90 002 Steel ruler

This steel ruler is a versatile tool for modelling, especially with its length of 30 centimetres. The zero point of the scale is exactly at the end of the ruler. The millimetre and half-millimetre scales as well as the numbers are etched in, so they are undamaged by cleaning.

The steel ruler is used not only for precise measuring in modelling, but also as a guide when cutting with the cutting knife No. 90 003 or the modelling knife No. 90 005.

Available from 10/2020

Length 300 mm

90 003

ALREADY
in stock
10/2020

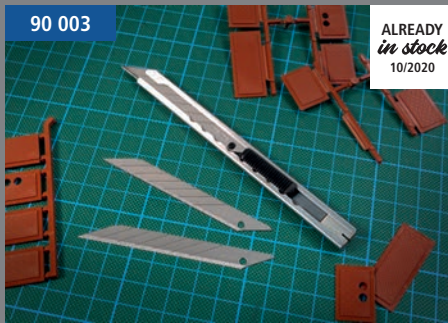

90 003 Cutting knife

The rugged metal design of this cutting knife is particularly suitable for precisely cutting Auhagen plastic panels. Paper and card can also be cut with great precision.

The pointed 30° snap-off blade is well suited for modelling work. In general, all 9 mm blades fit the knife.

When the cutting edge becomes blunt, it can be removed using the breaking-off tool located in the end of the handle. A pack of ten 30° replacement blades is included.

Further replacement blades are available using No. 90 004.

Available from 10/2020

90 004

ALREADY
in stock
10/2020

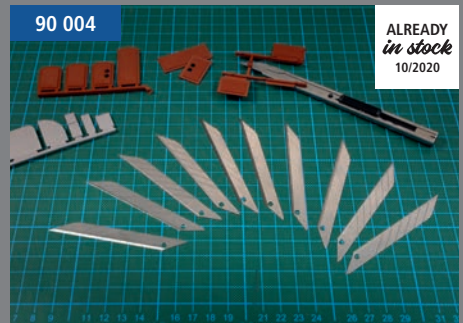

90 004 30° replacement blades

These 30° blades are very pointed and very sharp, making them ideal for modelling work. They can cut plastic, thin metal foils, card and paper, and are suitable for the cutting knife No. 90 003.

Pack of 10.

Available from 10/2020

90 009

ALREADY
in stock
10/2020



90 009 All-purpose scissors

A good pair of scissors belongs in every modelling workshop, and these particularly rugged scissors are very versatile. They have a long cutting area, permitting long, straight cuts to be made with ease. The blades are milled, making it easy to cut thicker materials because the material does not slip.

The scissors are suitable for paper and card, but they can also cut thinner plastic panels and even sheets of brass, nickel silver and copper up to a thickness of 0.3 mm.

A separable cross joint means the scissors can be dismantled for thorough cleaning without a tool. The cutting edges can be readjusted using an adjusting nut.

Available from 10/2020

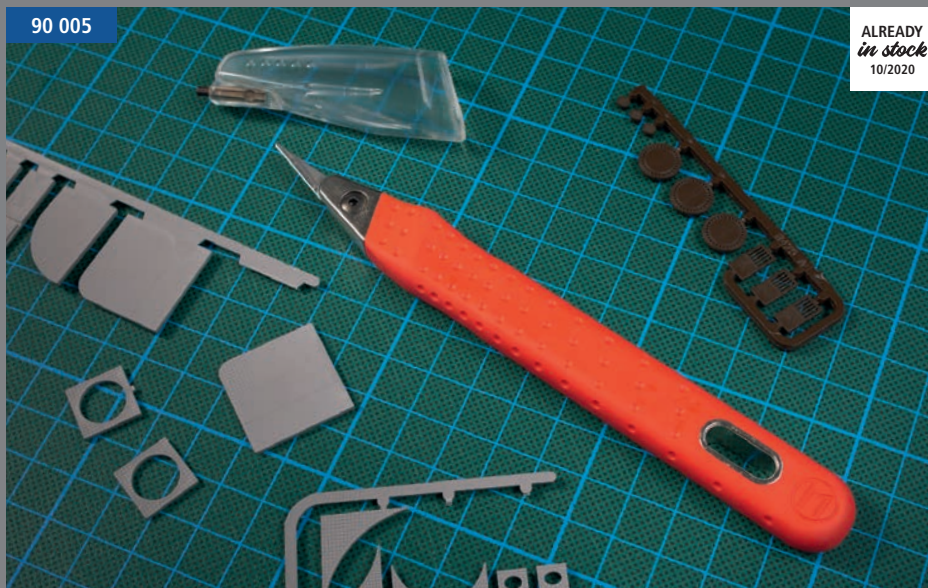

**90 005
Modelling knife**

With its non-slip handle, this high-quality modelling scalpel sits well and securely in the hand. In modelling, it is used for cutting paper, card and thin metal foils. The tough but flexible blade makes the knife also very well suited for the precise cutting of Auhagen plastic panels. The blade is easily replaced, using the Allen key in the protective cap to loosen and re-tighten the securing screw on the blade holder. Two versions of replacement blades are available: pointed (No. 90 007) and rounded/short (No. 90 006).
Available from 10/2020

**90 010
Plastic side cutter**

This side cutter is ideal for trimming sprue from components. The smooth cutting edge cuts without a bevel, leaving no residue on the component. The rugged design means that even thicker parts can be cut. The pointed format of the cutting edges means that even the smallest parts can be cut off without damage to them. The return spring and the non-slip plastic handles guarantee comfortable working.
Available from 10/2020

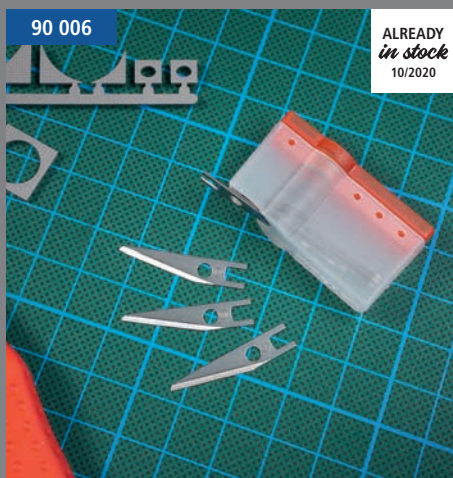

**90 006
Replacement blades for modelling knife – rounded/short**

10 replacement blades (rounded/short) for the precision knife No. 90 005. These very tough yet flexible knife blades are especially good for use in modelling. The special dispenser box allows the safe removal of individual blades.
Available from 10/2020

**90 007
Replacement blades for modelling knife – pointed**

10 replacement blades (pointed) for the precision knife No. 90 005. These very tough yet flexible knife blades are especially good for use in modelling. The special dispenser box allows the safe removal of individual blades.
Available from 10/2020

**90 008
Tweezers**

These pointed tweezers are manufactured from high-grade steel and have a matt lacquer in the grip area. The tips are ground flat on the inside and close very precisely, even after prolonged use. The tweezers make child's play of picking up and precisely positioning even the smallest components. A plastic cap to protect the tips and prevent accidents is included.
Available from 10/2020



90 011

ALREADY
in stock
10/2020**90 011**
Reamer set

This special tool belongs in every modelling workshop. It is used for enlarging drilled holes measuring in the range of tenths of a millimetre. It can also be used on holes that are not completely round, such as when there are small burrs or paint residues in the drilled hole. Holes can sometimes also be sealed with a thin layer of paint after painting. This can then be punctured and the hole enlarged.

The cutting edges and flutes run straight along the axis of the reamer, and reamers are tapered to be thinner toward the front. The cutting edge of the awl ends just before the handle, and the diameter of the shank is then of the desired size. Reamers are not suitable for drilling.

The pack contains 6 reamers in sizes from 0.6 mm to 2.0 mm.

Available from 10/2020

90 012

ALREADY
in stock
10/2020**90 012**
Warding files set

Warding files are versatile tools for modelling. The various file profiles – flat, square, round, half round, etc. – mean they can be used for all conceivable parts.

12 files with moulded handles.

Available from 10/2020

90 013

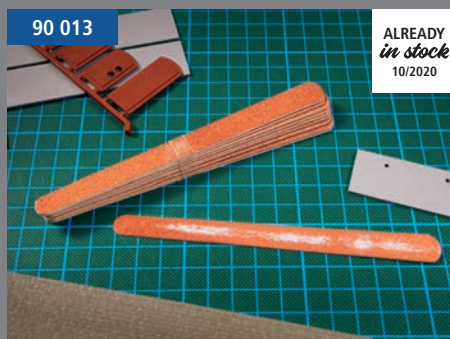
ALREADY
in stock
10/2020**90 013**
Modelling files

These simple files have a hard cardboard core and two differently grained sides – the red side is coarser than the yellow one. They are particularly suitable for the deburring and finishing of components, making it very easy to remove residual material still remaining on components after the removal of sprue, for example.

The modelling files are of a sufficient length to work with Auhagen plastic panels.

Pack of 10

Available from 10/2020

90 014

ALREADY
in stock
10/2020**90 014**
Hand-drill set

41-piece drill set with hand borer for plastic, wood and metal. Modelling often requires very fine holes to be drilled. The hand-drill set provides you with a wide selection of very thin drill bits. The diameters range from 0.6 mm to 2.5 mm in 0.1 mm increments.

The drill holder sits well in the hand and ensures precise working. There are two different clamping jaws to be selected depending on the size of the drill bit used.

Since the fine drill bits can break even when carefully used, the rugged and durable packaging contains duplicates of each size.

Available from 10/2020



99 134

99 134
Auhagen apron

Auhagen can also do fashion! Our modelling apron suits both him and her. Adjustable straps ensure a perfect fit when working in standing and sitting positions. The material is 100% easy-care cotton and very comfortable to wear. A large pocket provides a place to put all small components that would otherwise inevitably disappear.
Available from 10/2020

99 650
Auhagen vehicle catalogue

A handy catalogue of all Auhagen vehicle models, including one-off series. Provides modelling tips and many examples.
Available from 10/2020



99 133

99 133
Auhagen mug



Modelling and coffee – a wonderful combination. The Auhagen mug is a reliable companion for long evenings modelling. It sits well in the hand, and the Auhagen logo is in the middle of the mug, opposite the handle. This means that both left- and right-handed users can enjoy the stimulating hot drinks equally. Also suitable for tea, hot lemon and use outside of the modelling workshop.
Available from 10/2020



Tradition
seit
1885

WWW.AUHAGEN.DE

YOUR MODEL RAILWAY DEALER

Catalogue No. 16 was published in February 2020 and with the addition of the 2021 New Items Brochure, the catalogue is complete and valid. You can obtain a copy from your dealer or direct from us for 4.00 EUR plus postage.

Auhagen GmbH

OT Hüttengrund 25
09496 Marienberg/Erzgeb.
Tel.: + 49 (0) 37 35 . 66 84 66
E-Mail: info@auhagen.de
www.auhagen.de

