



AUTOMODELLE 1:87

2015/16







# Warum eigentlich ein Busch-Modell ???

## Liebe Sammler, liebe Modellbauer,

es ist schön, ein besonderes Hobby zu haben, ein Hobby, das überschaubar und vor allen Dingen bezahlbar bleibt. Busch-Automodelle erscheinen jedes Jahr in verschiedenen Varianten und in überschaubaren Stückzahlen, die den Modellmarkt nicht überschwemmen und Sie als Sammler nicht überfordern sollen. So bleibt es stets möglich, einen Modelltyp oder eine spezielle Sparte problemlos zu sammeln. Das Sammeln von Automodellen ist darüber hinaus längst keine alleinige Männerdomäne mehr, auch viele Frauen sind hinter den kleinen detailverliebten Kunststoff-Flitzern her. Die Smart-Aera dürfte wohl hier das Eis gebrochen haben. Vielleicht sind es aber auch die Vielfalt und das kreative Design der 1:87er Miniaturen, die sich aus der breiten Masse herausheben. Vielleicht sind es aber auch die Vielfalt und das kreative Design der 1:87er Miniaturen, die Details und Veränderungen machen es aus. Ausgefallene Bedruckungen, Beladungen und Gestaltungen machen aus bestehenden Modellformen plötzlich ein ganz anderes Fahrzeug. Die Realität gibt so viele Vorlagen, die wir immer wieder gerne einsetzen, um für Sie daraus ein Kunstwerk zu schaffen - Kunstwerke als Teil einer einzigartigen Sammlung oder

als besonderer Blickfang auf Modellbahnanlagen, Dioramen und Schaustücken eines im Detail arbeitenden Modellbauers.

Auch wenn ein spezielles Vorbild momentan durch seine vielen Besonderheiten als Modell nicht umsetzbar ist, wir probieren immer und immer wieder. So entwickeln wir spezielle Techniken, die uns eines Tages zum Erfolg führen und gleichzeitig neue Wege erschließen – ein weiterer Schritt in die Entwicklung ist getan. Wir legen nicht nur unseren eigenen Maßstab immer höher, Sie als Sammler oder Modellbauer profitieren auch davon und erhalten eine immer bessere und höhere Qualität. Vielleicht ist es Ihnen auch schon aufgefallen, unsere Drucke werden immer feiner und dünner, die Modelle immer detailreicher und spektakulärer – Kunstwerke en miniature »Made in Germany«.

Mit freundlichen Grüßen  
Ihr Busch-Team

## VORSCHLÄGE ?

Haben Sie zu Hause oder im Urlaub ein tolles Auto entdeckt, das als Druck- oder Formenneuheit interessant ist? Dann schnell ein Foto von allen vier Seiten des Fahrzeugs gemacht und zusammen mit den Infos ins Kuvert und ab an:  
Busch Automodelle,  
Postfach 12 60, D-68502 Viernheim

## FARBSORTIERUNG

Fast alle Fahrzeuge werden in mindestens zwei Farben sortiert geliefert. Über die aktuellen Farben und Farbänderungen informiert Sie gerne Ihr Fachhändler. Farbabweichungen und Farbänderungen gegenüber dem Katalog behalten wir uns vor.

## ERSATZTEILSERVICE

Ist ein kleines Teil verloren gegangen oder wurde etwas beschädigt? Kein Problem, gegen Einsendung von € 3,10 in Briefmarken können Sie diese Teile bei uns anfordern. Die Lieferung von Umrüstsätzen ist jedoch nicht möglich!



## FARBAUSWAHL

Die im Kästchen gezeigten »Pinsel« stehen für die Anzahl der lieferbaren Farben, d.h. bei zwei Pinseln ist das Modell in zwei verschiedenen Farben erhältlich, bei drei Pinseln in drei usw. Die aktuellen Farben finden Sie auf unserer Homepage: [www.busch-model.com](http://www.busch-model.com)

**NEU** Bereits seit Herbst 2014 lieferbar

**NEU** Neuheiten 2015









**1997** Baujahr des Grundmodells

Busch-Automodelle werden im Kunststoff-Spritzguss-Verfahren hergestellt. Abgebildete Neuheiten sind teilweise Prototypen. Farb-, Ausführungs- und Materialänderungen bei allen Modellen vorbehalten.

Audi-Modelle: Marken-, Geschmacksmuster- und Urheberrechte werden benutzt mit der Erlaubnis des Inhabers Audi AG. Mercedes-Benz-Modelle: Marken-, Geschmacksmuster- und Urheberrechte werden benutzt mit der Erlaubnis des Inhabers Daimler AG/Mercedes-Benz Accessories GmbH. Smart-Modelle: Marken-, Geschmacksmuster- und Urheberrechte werden benutzt mit der Erlaubnis des Inhabers Daimler AG/Smart GmbH. BMW-Modelle: Die Verwendung der BMW-Bildzeichen, das BMW-Wortzeichen sowie die BMW Modellbezeichnungen erfolgen aufgrund einer Lizenz der BMW AG.





 <p><b>40003 Benz-Patent-Motorwagen</b> <span style="float: right;">1886</span></p>	 <p><b>9838899 BMW Dixi</b> sortiert <span style="float: right;">1929</span></p>	 <p><b>41409 Mercedes-Benz 170V</b> Limousine <span style="float: right;">1936</span></p>	 <p><b>40202 BMW 327 Coupé</b> »CMD-Collection«, Rot <span style="float: right;">1938</span></p>	
 <p><b>99 87020 Austro-Daimler 28/35</b> Baujahr 1908</p>	 <p>Ansicht von hinten <b>NEU</b></p> <p><b>48308 Mercedes-Benz SSK</b> mit Koffer <span style="float: right;">1928</span></p>	 <p><b>41324 Horch 853</b> Cabrio geschlossen, Grün <span style="float: right;">1933</span></p>	 <p><b>40257 BMW 327</b> »CMD-Collection«, Blau <span style="float: right;">1938</span></p>	 <p><b>40205 BMW 327 Coupé</b> »CMD-Collection«, Braun <span style="float: right;">1938</span></p>
 <p><b>99 87010 Austro-Daimler 18/32</b> Cabrio geschlossen, Baujahr 1914</p>	 <p><b>41314 Horch 853</b> Cabrio offen, Metallic <span style="float: right;">1933</span></p>	 <p><b>41201 Ford Eifel</b> Cabriolimousine offen <span style="float: right;">1935</span></p>	 <p><b>40261 BMW 327</b> »CMD-Collection«, Gelb <span style="float: right;">1938</span></p>	 <p><b>40208 BMW 327 Coupé</b> Schwarz <span style="float: right;">1938</span></p>
 <p><b>99 87015 Austro-Daimler 18/32</b> Cabrio offen, Baujahr 1914</p>	 <p><b>41320 Horch 853</b> Cabrio geschlossen, Rot <span style="float: right;">1933</span></p>	 <p><b>41202 Ford Eifel</b> Cabriolimousine offen, Blau <span style="float: right;">1935</span></p>	 <p><b>9838852 Horch 930V Cabriolet</b> Cabrio offen, sortiert, Baujahr 1939 <span style="float: right;">1939</span></p>	
 <p><b>99 87035 Austro-Daimler ADR 22/70</b> Cabrio offen, Baujahr 1929</p>	 <p><b>41323 Horch 853</b> Cabrio geschlossen, Blau <span style="float: right;">1933</span></p>	 <p><b>41203 Ford Eifel</b> Cabriolimousine offen, Schwarz/Weiß <span style="float: right;">1935</span></p>	 <p><b>40501 Mercedes-Benz 170S</b> Cabrio geschlossen <span style="float: right;">1949</span></p>	 <p><b>42705 VW Käfer</b> »Beim Lackierer« <span style="float: right;">1951</span></p>



**1951** Ein VW Käfer kostet 4.400 DM

**1953** Jedes 3. Auto wird exportiert

**1955** Am 5. August läuft der millionste Käfer vom Band

**1956** 5,6 Millionen Autos werden zugelassen

**1958** Der VW Käfer ist das meist verkaufte Auto

 <p><b>42710 VW Käfer</b> mit Brezelfenster, Rot</p> <p>NEU</p> <p>1951</p>	 <p><b>42721 VW Käfer</b> mit Ovalfenster, Grau</p> <p>NEU</p> <p>1951</p>	 <p><b>42722 VW Käfer</b> mit Ovalfenster, Grün</p> <p>NEU</p> <p>1951</p>	 <p><b>9838323 Jaguar XKSS</b> Cabrio offen, sortiert</p> <p>1956</p>	
 <p><b>42711 VW Käfer</b> mit Brezelfenster, Blau</p> <p>NEU</p> <p>1951</p>			 <p><b>Messerschmitt Kabinenroller, KR 200 »Deluxe«</b> 48810 Weiß</p> <p>1956</p>	 <p><b>46500 Renault 4 CV</b> Limousine</p> <p>1958</p>
 <p><b>42712 VW Käfer</b> mit Brezelfenster, Schwarz</p> <p>NEU</p> <p>1951</p>			 <p><b>43100 Borgward Isabella</b> Coupé</p> <p>1958</p>	 <p><b>43910 Volvo 544</b> Schwarz</p> <p>NEU</p> <p>1958</p>
 <p><b>42720 VW Käfer</b> mit Ovalfenster, Beige</p> <p>NEU</p> <p>1951</p>			 <p><b>43150 Borgward Isabella</b> Cabrio</p> <p>1958</p>	 <p><b>43913 Volvo 544</b> Grün</p> <p>NEU</p> <p>1958</p>
 <p><b>9838893 Mercedes-Benz 190 SL</b> Cabrio offen, sortiert</p> <p>1955</p>			 <p><b>48000 Citroën DS 19</b> Limousine einfarbig</p> <p>1955</p>	 <p><b>43153 Borgward Isabella</b> Cabrio, Metallic</p> <p>1958</p>



**1960** Produktionsrekord: mehr als 2 Mio Kfz produziert    **1961** Borgward meldet Konkurs an    **1965** Die Kombis erobern den Automarkt    **1970** Jeder 4. Bundesbürger ist im Besitz eines PKW    **1973** Erstmals an 4 Sonntagen im Jahr ein Autofahrverbot

 <p><b>40401 Mercedes-Benz 220</b> »Rot«</p> <p>1959</p>	 <p><b>40403 Mercedes-Benz 220</b> »Grün«</p> <p>1959</p>	 <p><b>48700 Fiat 500 F</b> Schiebedach offen</p> <p>1965</p>	<p>Ansicht von hinten</p>  <p><b>48711 Fiat 500</b> »Wuppertal«</p> <p>1965</p>	 <p><b>48750 Puch 500</b> mit geschlossenem Schiebedach</p> <p>1965</p>
 <p><b>40402 Mercedes-Benz 220</b> »Blau«</p> <p>1959</p>	 <p><b>40416 Mercedes-Benz 220</b> »Hochzeit«</p> <p>1959</p>	 <p><b>48705 Fiat 500</b> »Fiat«</p> <p>1965</p>	 <p><b>48712 Fiat 500</b> »Illusion«, Metallic</p> <p>1965</p>	 <p><b>44960 Tabbert-Wohnwagen</b></p> <p>1971</p>
 <p><b>9838120 Jaguar E-Type</b> Cabrio geschlossen, sortiert</p> <p>1961</p>	 <p><b>43013 Toyota Land Cruiser J4</b> Metallic</p> <p>1960</p>	 <p><b>48716 Fiat 500</b> »Sport«, Rot</p> <p>1965</p>	 <p><b>50500 Lada 1500 (WAS 2103)</b> »CMD-Collection«, Beige</p> <p>1973</p>	
 <p><b>44401 Rolls Royce</b> »Hochzeit«</p> <p>1959</p> <p><b>NEU</b></p>	 <p><b>43014 Toyota Land Cruiser J4</b> mit Dachzelt, Grün</p> <p>1960</p> <p><b>NEU</b></p>	 <p><b>43015 Toyota Land Cruiser J4</b> mit Dachzelt, Beige</p> <p>1960</p> <p><b>NEU</b></p>	 <p><b>48717 Fiat 500</b> »Sport«, Weiß</p> <p>1965</p>	 <p><b>50501 Lada 1500 (WAS 2103)</b> »CMD-Collection«, Blau</p> <p>1973</p>
			 <p><b>48719 Fiat 500</b> »Leopard«</p> <p>1965</p>	 <p><b>50502 Lada 1500 (WAS 2103)</b> »CMD-Collection«, Orange</p> <p>1973</p>



**1975** neue Straßen von fast 1000 km werden gebaut     **1977** Mercedes präsentiert das T-Modell     **1980** Japan. Autohersteller haben 10% Marktanteil     **1983** VW präsentiert den Golf II

 <p><b>50509 Lada 1500</b> »Mauerfall«</p> <p>1973</p>	 <p><b>50553 Lada 1600</b> »CMD-Collection«, Grün</p> <p>1976</p>	 <p><b>42107 Opel Kadett C</b> »Swinger«, Polar-Weiß</p> <p>1977</p>	 <p><b>50301 Land Rover Defender</b> Grün</p> <p>1983</p>	 <p><b>43514 Toyota Land Cruiser HZJ 78</b> mit Dachzelt, Grün</p> <p>1985</p> <p><b>NEU</b></p>
 <p><b>50510 Lada 1500</b> »Lada«, Rot</p> <p>1973</p>	 <p><b>46800 Mercedes-Benz, W 123</b> T-Modell</p> <p>1977</p>	 <p><b>42108 Opel Kadett C</b> »Swinger«, Citrus-Gelb</p> <p>1977</p>	 <p><b>50302 Land Rover Defender</b> Blau</p> <p>1983</p>	 <p><b>50323 Land Rover Defender</b> »Orange«</p> <p>1983</p>
 <p><b>50511 Lada 1500</b> »Lada«, Grün</p> <p>1973</p>	 <p><b>46850 Mercedes-Benz, W 123</b> Limousine »Standard«</p> <p>1977</p>			 <p><b>50356 Land Rover Defender</b> »Memorandum«</p> <p>1983</p> <p><b>NEU</b></p>
 <p><b>50550 Lada 1600</b> »CMD-Collection«, Weiß</p> <p>1976</p>	 <p><b>46855 Mercedes-Benz, W 123</b> »CMD-Collection«</p> <p>1977</p>			 <p><b>43508 Toyota Land Cruiser HZJ 78</b> »Safari«</p> <p>1985</p>
 <p><b>50551 Lada 1600</b> »CMD-Collection«, Rot</p> <p>1976</p>	 <p><b>46858 Mercedes-Benz W123</b> Limousine »Unverwundlich«</p> <p>1977</p>	 <p><b>50300 Land Rover Defender</b> Weiß</p> <p>1983</p>	 <p><b>50312 Land Rover Defender</b> »Safari«</p> <p>1983</p> <p><b>NEU</b></p>	 <p><b>43515 Toyota Land Cruiser HZJ 78</b> »Globetrotter«</p> <p>1985</p> <p><b>NEU</b></p>



**1985** Ford stattet alle Modelle mit ABS aus

**1990** Autohersteller profitieren von der Wiedervereinigung

**1997** 41,4 Mio. Pkw's rollen auf deutschen Straßen

**2003** Jeder dt. Haushalt verfügt über 1,1 Autos

**2004** Für das Straßennetz 5,8 Mrd. € pro Jahr gebraucht



43554 Toyota Land Cruiser HZ J 78  
Gelb 1985



43555 Toyota Land Cruiser HZ J 78  
Beige 1985



48601 Mercedes-Benz A-Klasse  
Avantgarde, Metallic 1997



49400 Mercedes-Benz CLK-Klasse  
Cabrio 2003



49650 Audi A6 Avant 2004



43556 Toyota Land Cruiser HZ J 78  
Grün 1985



45708 Ford Escort  
Cabrio geschlossen, Grünmetallic 1991



48571 Mercedes-Benz M-Klasse ML55 AMG  
»Offroad«, (metallic) 1998



49455 Mercedes-Benz E-Klasse  
»CMD-Collection«, T-Modell 2003



49655 Audi A6 Avant  
»CMD-Collection« 2004



45701 Ford Escort  
Cabrio geschlossen, Rot 1991



45709 Ford Escort  
Cabrio geschlossen, Petrolmetallic 1991



49100 Mercedes-Benz C-Klasse  
»Elegance« 2000



9838829 Fiat Punto  
sortiert 2003



45702 Ford Escort  
Cabrio geschlossen, Schwarz 1991



45732 Ford Escort  
»Hochzeit«, Weinrot-Metallic 1991

**NEU**



9838811 Alfa Romeo 147  
sortiert



2000



49805 Mercedes-Benz M-Klasse W164  
»CMD-Collection« 2005



9838837 Ford RS200  
sortiert 1986



48535 Mercedes-Benz M-Klasse, Facelift  
»CMD-Collection«, ML 500 2001



9838876 Chrysler Crossfire Roadster  
sortiert 2003



**2005** Ab 1. Januar 2005 die bundesweite Lkw-Maut

**2005** VW präsentiert den Cross-Golf

**2007** Durchschnittspreis eines Autos liegt bei 25.000 EUR

**2008** 11.000 gr. Verkehrsstaus durch Autobahnbaustellen

**2009** „Aus“ für den schwedischen Autohersteller Saab



9838872 BMW M6  
sortiert

2005



41653 Mercedes-Benz E-Klasse  
Coupé »Hochzeit«, (metallisch)

2009



49810 Mercedes-Benz M-Klasse W164

2005



49705 Mercedes-Benz R-Klasse  
»CMD-Collection«

2006



41655 Mercedes-Benz E-Klasse  
Coupé, »CMD-Collection«, Hellblau

2009



46300 Mercedes-Benz GL-Klasse

2006



9838869 Dodge Caliber  
sortiert

2006

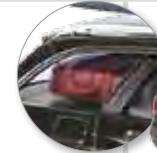

44262 Mercedes-Benz E-Klasse T-Modell  
mit Dachbox, Fahrrädern und Koffer im Inneren

2009



44258 Mercedes-Benz E-Klasse  
T-Modell, »CMD-Collection«, Hellblau

2009



46305 Mercedes-Benz GL-Klasse  
»CMD-Collection«

2006



43660 Mercedes-Benz C-Klasse  
T-Modell mit Panoramadach »Avantgarde«

2007



41657 Mercedes-Benz E-Klasse  
Coupé, »CMD-Collection«, Braun

2009



44253 Mercedes-Benz E-Klasse  
T-Modell, Schwarz

2009



44255 Mercedes-Benz E-Klasse  
T-Modell, »CMD-Collection«, Silbergrau

2009



49700 Mercedes-Benz R-Klasse

2006



41652 Mercedes-Benz E-Klasse  
Coupé, Grau

2009



44250 Mercedes-Benz E-Klasse  
T-Modell, Dunkelblau

2009



44254 Mercedes-Benz E-Klasse  
T-Modell, Grau

2009



44257 Mercedes-Benz E-Klasse  
T-Modell, »CMD-Collection«, Grün

2009



**2010** Ein Rolls-Royce Corniche kostet rund 750.000 EUR

**2011** Vorstellung des 1er BMW

**2012** Eine Mercedes-Benz S-Klasse kostet ca. 80.000 EUR

**2013** Elektrofahrzeuge kommen auf den Markt

**2014** BMW präsentiert den Hybridsportwagen i8



**49755 Mercedes-Benz GLK-Klasse**  
»CMD-Collection«, »Beige«

2009



**41675 Mercedes-Benz E-Klasse**  
Cabriolet, »CMD-Collection«, Blau

2010



**49756 Mercedes-Benz GLK-Klasse**  
»CMD-Collection«, »Grau«

2009



**41676 Mercedes-Benz E-Klasse**  
Cabriolet, »CMD-Collection«, Hellblau

2010



**49757 Mercedes-Benz GLK-Klasse**  
»CMD-Collection«, »Dunkelgrün«

2009



**41677 Mercedes-Benz E-Klasse**  
Cabriolet, »CMD-Collection«, Beige

2010



**41671 Mercedes-Benz E-Klasse**  
Cabriolet, Grau

2010



**41678 Mercedes-Benz E-Klasse**  
Cabriolet, »CMD-Collection«, Silber

2010



**41672 Mercedes-Benz E-Klasse**  
Cabriolet, Blau

2010



**43316 Mercedes-Benz ML-Klasse W166**  
»CMD-Collection«, Braun

2011



**51150 Mercedes-Benz V-Klasse**  
»CMD-Collection«, Silber

**51151 Mercedes-Benz V-Klasse**  
»CMD-Collection«, Weißmetalllic

**51152 Mercedes-Benz V-Klasse**  
»CMD-Collection«, Blaumetallic

2014

### Mercedes-Benz V-Klasse

Luxus pur und jede Menge Platz – die neue Großraumlimousine ist da! Das großartige Platzangebot ist ideal für alle Sportler, deren Freizeit hobby viel Platz benötigt, doch in erster Linie wurde diese geräumige Limousine für Familien konzipiert. Der Start-Preis des fahrenden Komfortwagens beginnt bei 43.000 Euro, der je nach Ausstattung auch bei 70.000 Euro enden kann. Da lohnt es sich allemal, zunächst in die Miniatur der formschönen Luxuslimousine zu investieren. Haarscharfe Konturen und feinste Bedruckungen geben das große Vorbild perfekt wieder. Die hellen klaren Scheinwerfer und der chromfolienbeprägte Kühlergrill sind ein unverkennbares Detail der Miniatur aus der »Sternen«-Flotte. Ein besonderer Glanzpunkt sind auch die edlen hauchzarten Speichenfelgen. Schaut man durch die großzügig gestalteten Fenster, so erkennt man auch ohne Lupe die komfortablen Sitze mit seitlichen Armlehnen. Beim Anblick des Modells lässt sich ohne weiteres erahnen, wie bequem man in seinem Vorbild über die Straßen fährt.



**50601 Mercedes-Benz Citan Kastenwagen**  
»CMD-Collection«, Silbermetalllic

2012



**50603 Mercedes-Benz Citan Kastenwagen**  
»CMD-Collection« Schwarzmetalllic

2012



**50651 Mercedes-Benz Citan Kombi**  
»CMD-Collection«, Weiß

2012



**50602 Mercedes-Benz Citan Kastenwagen**  
»CMD-Collection«, Blau

2012



**50650 Mercedes-Benz Citan Kombi**  
»CMD-Collection«, Rot

2012



**50652 Mercedes-Benz Citan Kombi**  
»CMD-Collection«, Schwarzmetalllic

2012





**NEU**

**49551 Smart Forfour 2014**  
»CMD-Collection«, Rotorange

2014



**NEU**

**49553 Smart Forfour 2014**  
»CMD-Collection«, Silber

2014



**NEU**

**49555 Smart Forfour 2014**  
»CMD-Collection«, Gelb

2014



**NEU**

**49557 Smart Forfour 2014**  
»CMD-Collection«, Grau

2014



**46164 Smart Crossblade**  
Rot

2002



**Smart Forfour 2014**

Der große Bruder. Das ultimative kleine Stadtauto Fortwo ist nicht länger alleine und hat wieder ein fünftüriges Pendant. Am Modell des neuen Fünftürers mit der sportlichen Note sind sehr schön alle Lichtkanten und haarscharfen Konturen erkennbar. Wie sein kleiner Bruder, das Coupé, hat auch der Forfour die interessante Wabenstruktur im Grill und prägt so mit den hellen chromhinterlegten Scheinwerfern das markante Gesicht. Auch die mehrfarbige Innenraumgestaltung setzt gemeinsam mit der kontrastreichen Außengestaltung Akzente. Hauchzarte Drucke von Fensterstreben, Glasdach, Frontscheibe, Nebelscheinwerfern und Rückfahrleuchten geben dem Modell eine ganz besondere Note.



**48985 Smart Crossblade**  
Schwarz

2002



**49302 Smart Roadster**  
»Traveller«, metallic

2003



**49304 Smart Roadster**  
»Collectors Edition«

2003



**46196 Smart City-Coupé**  
»Alu«

1998



**48918 Smart City Coupé**  
mit Skiträger, Ski u. Schneemann

1998



**48902 Smart Fortwo**  
»Facelift«

2000



**49300 Smart Roadster**

2003



**49355 Smart Roadster Coupé**  
»CMD-Collection«

2003





### 1002 Smart Car Tower

7-stöckiger Glasturm mit 2 Smart-Fahrzeugmodellen. Als Smart Verkaufsturm für Modellbahnanlagen oder Dioramen, und als Vitrine für Ihre Smart-Sammlung verwendbar (für 24 Smart-Modelle, Fertigmodell).  
Größe: 109 x 109 mm, 217 mm hoch

### 1000 Smart Verkaufsbäude

Bausatz für ein zwölfkockiges Verkaufsgebäude zur Gestaltung eines Smart-Verkaufcenters. Inklusive 1 Smart Roadster. Ideale Ergänzung zum Smart Car Tower Nr. 1001. Das Gebäude kann auch als »neutrales« Autohaus, Shopping-Center o.ä. verwendet werden.  
Größe: 195 x 195 mm, 85 mm hoch



NEU

50700 Smart Fortwo Coupé 2014  
»CMD-Collection«, Blau

2014



NEU

50701 Smart Fortwo Coupé 2014  
»CMD-Collection«, Rotorange

2014



NEU

50703 Smart Fortwo Coupé 2014  
»CMD-Collection«, Silber

2014



NEU

50706 Smart Fortwo Coupé 2014  
»CMD-Collection«, Braun

2014

### Smart Fortwo Coupé 2014

Das ultimative Stadtauto mit Kultstatus hat ein brandneues Design! Aber keine Sorge, das farblich zweigeteilte beliebte Erscheinungsbild bleibt auch weiterhin bestehen. Er ist jedoch um insgesamt zehn Zentimeter breiter geworden, was mehr Bewegungsfreiheit im Innern verspricht. Darüber hinaus ist auch die Front deutlich weiter nach vorn gezogen (»Fußgängerschutz«) und gibt dem ultrakurzen Zweisitzer eine größere »Knautschzone«. Die Miniatur des »Kleinen« zeigt frech sein neues Gesicht und wird dabei immer erwachsener. Der einst so belächelte kleine Flitzer hat

sich zu einem richtig durchgestylten Top-Fahrzeug gemauert. Immer eleganter und edler werden Farben, Design und Ausstattung. Im Modell ist der zweifarbige Innenraum noch immer bestimmend, ebenso die zweifarbige Außengestaltung mit den hellen chromhinterlegten Scheinwerfern. Beachtenswert sind auch die superfeinen Speichenfelgen sowie der Grill mit der interessanten Wabenstruktur. Die hauchzarten Drucke von Fensterstreben, Glasdach, Frontscheibe, Nebelscheinwerfern und Rückfahrleuchten sind da schon fast Nebensache.



49500 Smart Forfour

2004



46121 Smart Fortwo 07  
»Farbdesign Meisterschule 2010«

2007



49505 Smart Forfour  
»CMD-Collection«

2004



46105 Smart Fortwo 07  
Coupé »CMD-Collection«

2007



46116 Smart Fortwo 07  
»Parkplatzpirat«

2007



46129 Smart Fortwo 07  
»Gothic«

2007



46133 Smart Fortwo Cabrio 07  
Mattorange-Metallic

2007



46134 Smart Fortwo 07  
»Champion des Jahres«

2007



46175 Smart Fortwo Cabrio 07  
Cabrio »CMD-Collection«

2007







# SMART-MODELLE

Smart models · Modèles Smart

 <p><b>46200 Smart Fortwo Coupé</b> »CMD-Collection«, Schwarz</p> <p>2012</p>	<p><b>»Puzzle-Smarts«</b> Es ist wohl das leichteste und einfachste Puzzle der Welt, aber garantiert nicht das einfallsloseste. Die aufwändig gestaltete Bedruckung und das extravagante Design machen daraus ein ganz besonderes Sammlerstück.</p> 	 <p>Inkl. bedruckter Platte</p>	 <p><b>46119 Smart Fortwo 07</b> Puzzlesmart »skyline«</p> <p>2007</p>
 <p><b>46202 Smart Fortwo Coupé</b> »CMD-Collection«, Silbermetallic</p> <p>2012</p>	 <p>Inkl. bedruckter Platte</p>  <p><b>46117 Smart Fortwo 07</b> Puzzlesmart »pink skull«</p> <p>2007</p>	 <p>Inkl. bedruckter Platte</p>	 <p><b>46157 Smart Fortwo</b> Puzzlesmart »funfair«</p> <p>2000</p>
 <p><b>46272 Smart Fortwo Cabrio</b> »CMD-Collection«, Silbermetallic</p> <p>2012</p>	 <p>Inkl. bedruckter Platte</p>  <p><b>46118 Smart Fortwo 07</b> Puzzlesmart »Graffiti«</p> <p>2007</p>	 <p>Inkl. bedruckter Platte</p>	 <p><b>46127 Smart Fortwo 07</b> Puzzlesmart »Kleiner Feigling«</p> <p>2007</p>



# AMERIKANISCHE PKW 1950-1998

American vehicles 1950-1998 · Véhicules américains 1950-1998

 <p><b>44702 Buick '50</b> zweifarbige</p> <p>1950</p>	<p><b>NEU</b></p>  <p><b>44704 Buick 50</b> »Orange«, Metallic</p> <p>1950</p>	 <p><b>48229 Chevrolet Pick-up</b> »Deluxe«</p> <p>1950</p>	 <p><b>48230 Chevrolet Pick-Up</b> zweifarbige</p> <p>1950</p>	 <p><b>48232 Chevrolet Pick-up</b> »Metallica« Orange</p> <p>1950</p>
--	---	---	---	--





48233 Chevrolet Pick-up  
»Metallica« Violett

1950



NEU

45230 Ford Thunderbird  
Cabrio offen, Gelb



NEU

45232 Ford Thunderbird  
Cabrio offen, Blau



NEU

45233 Ford Thunderbird  
Cabrio offen, Rosa

1950



NEU

43421 Cadillac '52  
Cabrio, geschlossen »Rosé«



NEU

43423 Cadillac '52  
Cabrio, geschlossen »Braun«

1952



1957

45007 Chevrolet Bel Air  
Cabrio



1964

45409 Chevrolet Corvette  
Cabrio offen



1997

49000 Ford Crown Victoria  
Limousine, metallic



NEU

43428 Cadillac '52  
Coupé, zweifarbig »Grün«



NEU

43430 Cadillac '52  
Coupé, zweifarbig »Gelb«

1952



45104 Cadillac Eldorado '59  
»Metallica«, Rosé-metallic



45105 Cadillac Eldorado '59  
»Metallica«, Hellblau-metallic

1959



NEU

44723 Buick '50  
»Deluxe«, Grün-metallic



NEU

44724 Buick '50  
»Deluxe«, Silber-metallic

1952



1964

47500 Ford Mustang



1964

47509 Ford Mustang  
»Hochzeit«



1964

47512 Ford Mustang  
»Metallica«, Grün



Ford Thunderbird  
45200 mit Hardtop, Silber-metallic

1956



45201 mit Hardtop, Graulila-metallic

1956



1964

47511 Ford Mustang  
»Metallica«, Goldbraun



NEU

42919 Cadillac 70 Station Wagon  
»Bestattungsinstitut«

1970



 <p><b>44982 Airstream Wohnwagen</b> 1958</p>	 <p><b>9838597 Ford Hot Rod Roadster</b> Sortiert in den Farben Grün und Gelb 1932</p>	 <p><b>44656 Dodge Ram Van</b> »Crazy Cars«, metallic 1984</p>	 <p><b>9838661 Chrysler PT Cruiser</b> »Pink Flame« 2000</p>
 <p><b>44500 Amerikanischer Bus »Fishbowl«</b> Grün 1959</p>	 <p><b>48706 Fiat 500</b> »Crazy Cars« 1965</p>	 <p><b>43512 Toyota Landcruiser HZJ 78</b> »Crazy Cars« 1985</p>	 <p><b>40152 US-Motorrad</b> Blau-Metallic NEU</p>
 <p><b>44504 Amerikanischer Bus »Fishbowl«</b> »Information Campaign Bus« 1959</p>	 <p><b>40153 US-Motorrad</b> Rot-Metallic NEU</p>	 <p><b>40156 US-Motorrad</b> Gold-Metallic NEU</p>	 <p><b>40158 US-Motorrad</b> Oliv-matt NEU</p>
 <p><b>44530 Amerikanischer Bus »Fishbowl«</b> DESIGN LINE »Oakville« 1959</p>	 <p><b>41003 Mercedes O-3500</b> »Luc's« 1949</p>	 <p><b>41005 Mercedes O-3500</b> »Marburg« 1949</p>	<p>NEU</p>
 <p><b>44535 Amerikanischer Bus »Fishbowl«</b> DESIGN-LINE »Calgary« 1959</p>	 <p><b>41045 Mercedes O-3500</b> Reisebus 1949</p>	 <p><b>41051 Mercedes-Benz O-3500</b> »Schulbus« Baujahr 1949 1949</p>	





# POST- & TAXI- FAHRZEUGE

Postal vehicles / Taxi cars · Véhicules postaux / Taxi Voitures



41035 Mercedes-Benz O-3500  
»Schweizer Postbus«



1949



44260 Mercedes-Benz E-Klasse, T-Modell  
»Taxi«

2003



44269 Mercedes-Benz E-Klasse T-Modell  
»Taxi«

2009



50656 Mercedes-Benz Citan Kombi  
»Taxi«

NEU

2012



41046 Mercedes-Benz O-3500  
»Postbus Österreich«

1949



47845 Mercedes-Benz Sprinter  
»Post Schweiz«

1995



50606 Mercedes-Benz Citan Kastenwagen  
»Deutsche Post«

2012



42727 VW Käfer  
»Taxi«

1951

NEU



42109 Opel Kadett C  
»Taxi«

1977

NEU



49702 Mercedes-Benz R-Klasse  
»Taxi«

2006

NEU



50512 Lada 1500  
»Taxi«

1973

NEU



44211 Mercedes-Benz E-Klasse Limousine  
»Taxi NYC«

2009



40415 Mercedes-Benz W123  
»Taxi«

1959

NEU



46862 Mercedes-Benz W123 Limousine  
»Taxi«

1977



46123 Smart Fortwo 07  
»Taxi«

2007



49029 Ford Crown Victoria  
»Dispatch Taxi«

1997



43314 Mercedes-Benz ML-Klasse  
»Taxi NYC«

2011





**NEU**

### Unimog U 5023 Feuerwehr

Die neue Baureihe des Unimog U 5023 ähnelt zwar äußerlich den bewährten Vorgängern, wurde jedoch technisch auf den neuesten Stand gebracht. Die neuen Fahrzeuge setzen neue Maßstäbe in Wirtschaftlichkeit, Umweltschutz und Bedienerfreundlichkeit. Unverändert sind die altbewährten Unimog Tugenden wie Langlebigkeit, Robustheit, Effizienz und eine enorme Geländegängigkeit. Der Unimog der Feuerwehr mit Ziegler-Aufbau nimmt jede Unebenheit mühelos und ist auch in unwegsamem Gelände

ein Meister seines Fachs. Die Brandbekämpfung ist für ihn kein Problem. Perfekt ist auch die Umsetzung des großen Vorbildes in miniature. Das Modell mit den grobstolligen Reifen begeistert durch den kantigen Aufbau mit fünf silber lackierten Rolltüren, einer filigranen Dachreling mit Aufstiegsleiter sowie verschiedenen Dachboxen in »Riffelblechoptik«, die ebenso wie die komplette Dachabdeckung silber lackiert sind.

51050 Mercedes-Benz Unimog U 5023 mit Kastenaufbau »Feuerwehr«

2014



### 42770 VW Käfer

»Feuerwehr Schwenningen«

1951



### 50202 Robur LO 2002 A

»Feuerwehr Weiden«

1973



### 50801 Hanomag AL 28 MKW

Feuerwehr Hamburg

1958



### 50205 Robur LO 2002 A

»Vorbildliche Freiwillige Feuerwehr«

1973



### 42401 Ford Transit

»Einsatzleitung«

1965



### 50208 Robur LO 2002 A

»Feuerwehr Naitschau«

1973



### 50105 Lada 2101

»Feuerwehr«

1971



### 50218 Robur LO 2002 A

»IFA Feuerwehr«

1973



42863 Flüssigmisttankanhänger  
»Feuerwehr Züllsdorf«



42826 Traktor Fortschritt ZT303  
»Feuerwehr Authausen« mit Anhänger

1967



50200 Robur LO 2002 A  
»Wasserwehr«

1973



50225 Robur LO 2002 A  
»Feuerwehr Ellrich« Gerätewagen

1973

**NEU**





# FEUERWEHR

Fire Department vehicles · Véhicules des pompiers



47846 Mercedes-Benz Sprinter  
»Feuerwehr« mit Tandemanhänger

1995



49758 Mercedes-Benz GLK-Klasse  
»Feuerwehr Leipzig«

2009



46008 American LaFrance Pumpwagen  
»Scotland Vol. Fire Department«

1970



46518 Renault 4CV  
»Feuerwehr Paris«

1958



50307 Land Rover Defender  
»Feuerwehr Dortmund«

1983



49662 Audi A6 Avant  
»Feuerwehr Dessau«

2004



49764 Mercedes-Benz GLK-Klasse  
»Freiwillige Feuerwehr«

2009



1450 Feuerwehr-Gebäude (Requisitenhaus)



50311 Land Rover Defender  
»Feuerwehr Schneverdingen«, metallic

1983



48474 Piaggio Ape 50  
»Feuerwehr Augsburg«

2006



49759 Mercedes-Benz GLK-Klasse  
»Feuerwehr«

2009



50320 Land Rover Defender  
»Knorr Betriebswehr«

1983



43657 Mercedes-Benz C-Klasse T-Modell  
Avantgarde »Feuerwehr«

2007



49765 Mercedes-Benz GLK-Klasse  
»Feuerwehr Emmendingen«

2009



44550 Amerikanischer Bus »Fishbowl«  
New York »Fire Department«

1959



42210 Multicar  
»Feuerwehr Cottbus«

1991



43658 Mercedes-Benz C-Klasse T-Modell  
»Feuerwehr Bremen«

2007



46303 Mercedes-Benz GL-Klasse  
»Feuerwehr Dänemark«

2006



48718 Fiat 500  
»Feuerwehr Holland«

1965



41856 Ford E-350  
»F.D.N.Y.«

1992





### Aufklappbar

Die Rolltore der Fahrzeuge mit zweigeteiltem Aufbau lassen sich wechselseitig öffnen, so dass man sie mit verschiedenen Gerätschaften (Feuerlöscher, Werkzeugkisten, Spaten, Eimer usw.), die der Packung beiliegen, ausstatten kann.

**Aufklappbar!**



**43855 Mercedes-Benz MK 88 1222**  
»Feuerwehr Dortmund«, 3-geteilter Aufbau 1988



**43859 Mercedes-Benz MK 88 1225**  
»Minis Feuerwehr Hürth« 1988



**43808 Mercedes-Benz MK 94 1224**  
»Feuerwehr Bühl« 1994



**43851 Mercedes-Benz MK 88 1222**  
»Feuerwehr Hasbergen« 1988



**43858 Mercedes-Benz MK 88 1224**  
»Feuerwehr Holzkirchen« 1988



**43805 Mercedes-Benz MK 94 1224**  
»Feuerwehr Moorrege« 1994



**43812 Mercedes-Benz MK 94 1224**  
»Feuerwehr Weinböhl« 1994



**43853 Mercedes-Benz MK 88 1222**  
»Feuerwehr Hanau« 1988



**43801 Mercedes-Benz MK 94 1424**  
Löschgruppenfahrzeug, »Feuerwehr Schwelm« 1994



**43806 Mercedes-Benz MK 94 1224**  
»Feuerwehr Mönchengladbach« 1994



**43813 Mercedes-Benz MK 94 1224**  
»Feuerwehr Fürth« 1994



**43854 Mercedes-Benz MK 88 1222**  
»Feuerwehr Dortmund« 1988



**43803 Mercedes-Benz MK 94 1424**  
Löschgruppenfahrzeug, »Feuerwehr Kaltenkirchen« 1994



**43807 Mercedes-Benz MK 94 1224**  
»Feuerwehr Winterberg« 1994



**43814 Mercedes-Benz MK 94 1224**  
»Feuerwehr Kaufbeuren« 1994





NEU

50803 Hanomag AL 28 MKW  
»ASB«

1958



41834 Ford E-350  
»DRK Notarzt«

1992



49808 Mercedes-Benz M-Klasse W164  
»Baby-Notarzt«

2005



43656 Mercedes-Benz C-Klasse T-Modell  
»Notarzt«, metallic

2007



NEU

50653 Mercedes-Benz Citan Kombi  
»First Responder«, metallic

2012



NEU

50806 Hanomag AL 28 MKW  
»Rotes Kreuz, Technischer Dienst«

1958



46152 Smart Fortwo Coupé  
»DRK«

2000



49811 Mercedes-Benz M-Klasse W164  
»Malteser Notarzt«

2005



44261 Mercedes-Benz E-Klasse T-Modell  
»Notarzt Dortmund«

2009



46162 Smart Fortwo 07  
»St. John Ambulance«

2007



NEU

50809 Hanomag AL 28 MKW  
»Malteser«

1958



46159 Smart Fortwo  
»Johanniter«, metallic

2000



49816 Mercedes-Benz M-Klasse W164  
»Notarzt«

2005



49762 Mercedes-Benz GLK-Klasse  
»DRK«

2009



49814 Mercedes-Benz M-Klasse W164  
»Notarzt Dänemark«

2005



NEU

50319 Landrover Defender  
»Malteser«

1983



49661 Audi A6 Avant  
»Ambulanzflugdienst«

2004



49817 Mercedes-Benz M-Klasse W164  
»DRK Notarzt«

2005



49768 Mercedes-Benz GLK-Klasse  
»Notarzt«

2009



42918 Cadillac 70 Station Wagon  
»Ambulance«

1970



50309 Land Rover Defender  
»Johanniter«

1983



49276 Audi A4 Avant  
»BRK Notarzt«

2005



48479 Piaggio Ape 50  
»Johanniter«

2006



43313 Mercedes-Benz ML-Klasse W166  
»Malteser Notarzt«

2011

NEU





41403 Mercedes-Benz 170V Cabrio  
»Länderpolizei«

1936



50209 Robur LO 2002 A  
»Bereitschaftspolizei«

1973



NEU

50560 Lada 1600  
»Volkspolizei Führungsfahrzeug«

1976



NEU

50561 Lada 1600  
»Volkspolizei Schlussfahrzeug«

1976



43857 Mercedes-Benz SK88  
»Polizei«

1988



NEU

41404 Mercedes-Benz 170V Cabrio  
»Bereitschaftspolizei«

1936



NEU

41405 Mercedes-Benz 170V Cabrio  
»Polizei Berlin«

1936



NEU

40922 DKW 3=6  
»Polizei«

1956



47844 Mercedes-Benz Sprinter  
»Polizei«, metallic

1995



46861 Mercedes-Benz W123 Limousine  
»Autobahnpolizei«

1997



46155 Smart Fortwo Coupé  
»Polizei«, metallic

2000



50103 Lada 2101  
»Polizei Sachsen«

1971



50104 Lada 2101  
»Polizei Berlin«

1971



50216 Robur LO 2002 A  
»Polizei«

1973



46860 Mercedes-Benz W123 Limousine  
»Polizei«

1977



49163 Mercedes-Benz C-Klasse, T-Modell  
»Polizei«, metallic

2001



 <p><b>43661 Mercedes-Benz C-Klasse T-Modell</b> Avantgarde »Polizei«, Blau (metallic) <span style="float: right;">2007</span></p>	 <p><b>44264 Mercedes-Benz E-Klasse T-Modell</b> »Polizei« Filmfahrzeug mit abnehmbarem Schriftzug und Blaulicht-Abdeckung (metallic) <span style="float: right;">2009</span></p>	 <p><b>50710 Smart Fortwo Coupé 2014</b> »Polizei« <span style="float: right;">2014</span></p>	 <p><b>50508 Lada 1500</b> »Polizei Tschechien« <span style="float: right;">1973</span></p>	
 <p><b>43662 Mercedes-Benz C-Klasse T-Modell</b> Avantgarde »Polizei«, Grün (metallic) <span style="float: right;">2007</span></p>	 <p><b>44264 Mercedes-Benz E-Klasse T-Modell</b> »Polizei« Filmfahrzeug mit abnehmbarem Schriftzug und Blaulicht-Abdeckung (metallic) <span style="float: right;">2009</span></p>	 <p><b>46125 Smart Fortwo 07</b> »Polizei Luxemburg« <span style="float: right;">2007</span></p>	 <p><b>49026 Ford Crown Victoria</b> »Marshal« <span style="float: right;">1997</span></p>	
 <p><b>43663 Mercedes-Benz C-Klasse T-Modell</b> Avantgarde »Polizei-Zivildfahrzeug« (metallic) <span style="float: right;">2007</span></p>	 <p><b>46120 Smart Fortwo 07</b> »Polizei« (metallic) <span style="float: right;">2007</span></p>	 <p><b>46209 Smart Fortwo Coupé 2012</b> »Polizei Sachsen« <span style="float: right;">2012</span></p>	 <p><b>50310 Land Rover Defender</b> »Gendamerie« <span style="float: right;">1983</span></p>	 <p><b>49027 Ford Crown Victoria</b> »Helper Police« <span style="float: right;">1997</span></p>
 <p><b>43664 Mercedes-Benz C-Klasse T-Modell</b> Elegance »Polizei Thüringen« (metallic) <span style="float: right;">2007</span></p>	 <p><b>44267 Mercedes-Benz E-Klasse T-Modell</b> »Autobahnpolizei«, Silber-metallic <span style="float: right;">2009</span></p>	 <p><b>50658 Mercedes-Benz Citan Kombi</b> »Polizei« (metallic) <span style="float: right;">2012</span></p>	 <p><b>49818 Mercedes-Benz M-Klasse W164</b> »Politi« Polizei Norwegen <span style="float: right;">2005</span></p>	 <p><b>9838961 Chrysler PT Cruiser</b> »School Resource Office Car« <span style="float: right;">2000</span></p>
 <p><b>43665 Mercedes-Benz C-Klasse T-Modell</b> Avantgarde »Polizei Baden-Württemberg« (metallic) <span style="float: right;">2007</span></p>	 <p><b>44268 Mercedes-Benz E-Klasse T-Modell</b> »Autobahnpolizei«, Weiß <span style="float: right;">2009</span></p>	 <p><b>50659 Mercedes-Benz Citan Kombi</b> »Autobahnpolizei« <span style="float: right;">2012</span></p>	 <p><b>50562 Lada 1600</b> »Patrulla« Polizei Kuba <span style="float: right;">2005</span></p>	 <p><b>49813 Mercedes-Benz M-Klasse W 164</b> »Beverly Hills Police D.A.R.E.« <span style="float: right;">2005</span></p>





 <p>25005 Messerschmitt Bf 109 G6, Tschechoslowakei Luftwaffen-Polizei <span style="float: right;">1939</span></p>	 <p>25007 Messerschmitt Bf 109 G6, »Reichsverteidigung« <span style="float: right;">1939</span></p>	 <p>25009 Messerschmitt Bf 109 G2, »Nahauflärungsgruppe 11« <span style="float: right;">1939</span></p>		
 <p>25010 Messerschmitt Bf 109 F4, »Oswald Fischer« <span style="float: right;">1939</span></p>	 <p>25011 Messerschmitt Bf 109 F4, »Britisches Beuteflugzeug« <span style="float: right;">1939</span></p>	 <p>25012 Messerschmitt Bf 109 G2, Jagdbomber <span style="float: right;">1939</span> <b>NEU</b></p>		
 <p>25013 Messerschmitt Bf 109 G6, Finnisches Jagdflugzeug mit Markierung vom Luftrennen 1950 (späte Ausführung) <span style="float: right;">1939</span></p>	 <p>25055 Messerschmitt Bf 109 G2, Jagdfliegergalerie »Heinrich Ehrler« <span style="float: right;">1939</span></p>	 <p>25056 Messerschmitt Bf 109 G2, Jagdfliegergalerie »Johannes Steinhoff« <span style="float: right;">1939</span></p>		
 <p>25057 Messerschmitt Bf 109 G4, Jagdfliegergalerie »Wolfgang Tonne« <span style="float: right;">1939</span></p>	 <p>25058 Messerschmitt Bf 109 F2, Jagdfliegergalerie »Hans Phillip« <span style="float: right;">1939</span></p>	 <p>25059 Messerschmitt Bf 109 F2, Jagdfliegergalerie »Adolf Galland« <span style="float: right;">1939</span> <b>NEU</b></p>	 <p>47728 Ford Modell AA »Leichter Funkwagen« <span style="float: right;">1931</span></p>	 <p>41563 Mercedes-Benz 170V »Stabsfahrzeug« <span style="float: right;">1936</span></p>
 <p>41564 Mercedes-Benz 170V »Schneeräumfahrzeug« mit Schneeschieber <span style="float: right;">1936</span></p>	 <p>41402 Mercedes-Benz 170V »Zugfahrzeug mit Bombenkarren« <span style="float: right;">1936</span></p>	 <p>41406 Mercedes-Benz 170V »Wehrmacht« <span style="float: right;">1936</span> <b>NEU</b></p>		



 <p><b>41103 Opel Olympia</b> »Infanterie Pionierfahrzeug«</p> <p>1938</p>	 <p><b>42835 Traktor Fortschritt ZT 300</b> »Bundeswehr«</p> <p>1967</p>	 <p><b>50506 Lada 1500</b> »Patrouillier-Fahrzeug«</p> <p>1973</p>	 <p><b>50507 Lada 1500</b> »Volkspolizei«</p> <p>1973</p>	 <p><b>50563 Lada 1600</b> »Sowjetische Armee«</p> <p>1976</p> <p><b>NEU</b></p>
 <p><b>41104 Opel Olympia</b> mit Tarnnetz</p> <p>1938</p> <p><b>NEU</b></p>	 <p><b>50206 Robur LO 2002 A</b> »Zivilverteidigung«</p> <p>1973</p>			 <p><b>41401 Mercedes-Benz 170V</b> »Dienstfahrzeug der amerik. Besatzungstruppen«</p> <p>1936</p>
 <p><b>40253 BMW 327 Cabrio</b> »Feldgendarmarie«</p> <p>1938</p>	 <p><b>50217 Robur LO 2002 A</b> »NVA« offene Plane</p> <p>1973</p>			 <p><b>43002 Toyota Land Cruiser</b> »UN«</p> <p>1960</p>
 <p><b>42704 VW Käfer</b> »Kleines Tank- und Instandsetzungsfahrzeug«</p> <p>1949</p>	 <p><b>50221 Robur LO 2002 A</b> »Grenztruppe«, mit Kofferaufbau</p> <p>1973</p>	 <p><b>50227 Robur LO 2002 A</b> »Kommandantendienst Führungsfahrzeug«</p> <p>1973</p> <p><b>NEU</b></p>	 <p><b>44210 Mercedes-Benz E-Klasse Limousine</b> »Feldjäger«</p> <p>2009</p>	 <p><b>50304 Land Rover Defender</b> mit Tarnflecken</p> <p>1983</p>
 <p><b>42831 Traktor Fortschritt ZT303</b> »Grenztruppe«</p> <p>1963</p>	 <p><b>50222 Robur LO 2002 A</b> »NVA Grenztruppe«</p> <p>1973</p>	 <p><b>50228 Robur LO 2002 A</b> »Kommandantendienst Schlussfahrzeug«</p> <p>1973</p> <p><b>NEU</b></p>	 <p><b>43011 Toyota Land Cruiser J4</b> mit Airstream »Hospital«</p> <p>1960</p>	





**NEU**

**80105 Sturmpanzer VI »Sturmtiger«**  
Sandgelb



**NEU**

**80100 Tiger**  
»Tiger Nr. 216«



**NEU**

**80101 Tiger**  
»Tiger Nr.13-13«



**NEU**

**80102 Jagdpanzer VI »Jagdtiger«**  
Sandgelb



**NEU**

**80103 Panzer »Königtiger« (Porsche)**  
Sandgelb



**NEU**

**80104 Panzer »Königtiger« (Henschel)**  
Sandgelb

**Military Edition 1:87**

Fahrzeugmodelle in vorbildgerechter Ausführung für alle Militärfans und -Veteranen der oliv- und feldgrauen Fahrzeug- und Panzerflotte. Jedes Modell ist ein spezielles Sammlerstück, das in Form- und Farbgebung sowie der entsprechenden Bedruckung dem jeweiligen Vorbildfahrzeug aus dem 2. Weltkrieg angeglichen ist.





 <p><b>80000 Horch 108 Typ 40</b> »Wehrmachtsfahrzeug«</p>	 <p><b>80020 Ford V8 G917 T</b> »Einheitslastwagen«</p>
 <p><b>80001 Horch 108 Typ 40</b> mit Flakgeschütz</p>	 <p><b>80040 Magirus Klöckner-Humboldt-Deutz (KHD)</b> »Material- und Personentransporter«</p>
 <p><b>80002 Horch 108 Typ 40</b> »Mannschaftskraftwagen«</p>	 <p><b>80041 Magirus Klöckner-Humboldt-Deutz (KHD) S3000</b> »Funkkraftwagen«</p>
 <p><b>80021 Ford V8 G917T</b> »Betriebsstoffwagen«</p>	 <p><b>80060 Opel Ersatz. Kfz. 385 (Mercedes L 701)</b> »Flugbetriebsstoffkesselwagen«</p>

# OXFORD

## Oxford Automodelle 1:87

Modellautos des englischen Herstellers »Oxford Diecast« begeistern Sammler unterschiedlichster Fahrzeugepochen und Maßstäbe. Dazu gehören jetzt H0-Fahrzeuge im Maßstab 1:87 in Metallausführung. Die Modelle werden in transparenten Displayboxen präsentiert und in attraktiven Kartonfaltschachteln mit Sichtfenster geliefert.



**201107281 Lincoln Continental**  
Rotbraun 1941



**201108592 Lincoln Continental**  
Grau 1941



**201107328 Mercury**  
Grünmetalllic 1949



**201107267 Ford Thunderbird**  
Lachsrot 1956



**201107304 Ford Edsel Citation**  
Schwarz/Rot, Baujahr 1958 1958



 <p><b>5804 Hanomag AL 28 MKW</b> »THW / Bergungsdienst«</p> <p>1958</p> <p><b>NEU</b></p>	 <p><b>46153 Smart City Coupé</b> »T H W«</p> <p>1998</p>	 <p><b>43008 Toyota J4</b> »Surf Rescue«</p> <p>1960</p>	 <p><b>50654 Mercedes-Benz Citan Kombi</b> »Follow me«</p> <p>2012</p> <p><b>NEU</b></p>	 <p><b>50916 Mercedes-Benz Unimog U 430</b> »Einsatzfahrzeug«, Weiß</p> <p>2013</p> <p><b>NEU</b></p>
 <p><b>50213 Robur LO 2002 A</b> »T H W«</p> <p>1973</p>	 <p><b>50314 Land Rover Defender</b> »DLRG« mit Dachgepäckträger</p> <p>1983</p>	 <p><b>43503 Toyota Land Cruiser HZ J78</b> »Bergwacht Nürnberg«</p> <p>1985</p>	 <p><b>41004 Mercedes-Benz O-3500</b> »Übertragungswagen«</p> <p>1949</p>	 <p><b>50917 Mercedes-Benz Unimog U 430</b> »Einsatzfahrzeug«, Silber-metallic</p> <p>2013</p> <p><b>NEU</b></p>
 <p><b>50224 Robur LO 2002 A</b> »T H W«</p> <p>1973</p> <p><b>NEU</b></p>	 <p><b>46132 Smart Fortwo 07</b> »DLRG«</p> <p>2007</p>	 <p><b>48483 Piaggio Ape 50</b> »ADAC«</p> <p>2006</p>	 <p><b>50802 Hanomag AL 28 MKW</b> »Messwagen«</p> <p>1958</p>	 <p><b>50918 Mercedes-Benz Unimog U 430</b> »Einsatzfahrzeug«, Gelb</p> <p>2013</p> <p><b>NEU</b></p>
 <p><b>50318 Landrover Defender</b> »T H W«</p> <p>1983</p> <p><b>NEU</b></p>	 <p><b>44924 Anhänger mit Schlauchboot</b> »DLRG«</p>	 <p><b>41504 Mercedes-Benz 170V</b> »MBB Flugzeugbau«</p> <p>1936</p> <p><b>NEU</b></p>	 <p><b>50807 Hanomag AL 28 MKW</b> »Archäologe«</p> <p>1958</p> <p><b>NEU</b></p>	 <p><b>50901 Mercedes Unimog U 430</b> Blau</p> <p>2013</p>
 <p><b>40784 Mercedes-Benz LP809</b> »T H W«</p> <p>1992</p>	 <p><b>50212 Robur LO 2002 A</b> »Wasserwehr«</p> <p>1973</p>	 <p><b>46128 Smart Fortwo 07</b> »Follow me«</p> <p>2007</p> <p><b>NEU</b></p>	 <p><b>46151 Smart Fortwo Coupé</b> »Klo &amp; Co.«</p> <p>2000</p>	 <p><b>50902 Mercedes Unimog U 430</b> Grün</p> <p>2013</p>





**NEU**

**51100 Mercedes-Benz Vito**  
»CMD-Collection«, Silber

2014



**NEU**

**51101 Mercedes-Benz Vito**  
»CMD-Collection«, Weißmetall

2014



**NEU**

**51104 Mercedes-Benz Vito**  
»CMD-Collection«, Schwarzmetall

2014



**NEU**

**51107 Mercedes-Benz Vito**  
Blau

2014

### Mercedes-Benz Vito

Was für die Familie und Freizeit die V-Klasse, das ist für Handwerker und Gewerbetreibende der Vito. Beim Interieur hat man sich bei der Gestaltung des noblen Kastenwagens absichtlich an die des beliebten Sprinters gehalten, da sich diese bereits bewährt hatte. Dennoch handelt es sich bei dem noblen Kastenwagen um ein Nutzfahrzeug, daher ist er mit einem unlackierten Stoßfänger ausgestattet, so lassen sich die Folgen eventueller kleiner »Einparkschwierigkeiten« leichter wegstecken und er verleiht dem Wagen zudem eine robustere Optik. Der luxuriöse Kastenwagen mit seinen haarscharfen Konturen und feinsten Bedruckungen ergänzt die Miniatur-»Sternen«-Flotte durch ein weiteres Highlight. Mit seinen hellen klaren Scheinwerfern und dem chromfolienbeprägten Kühlergrill wird das Vorbild mit all seinen unverkennbaren Details wiedergegeben.

rigkeiten« leichter wegstecken und er verleiht dem Wagen zudem eine robustere Optik. Der luxuriöse Kastenwagen mit seinen haarscharfen Konturen und feinsten Bedruckungen ergänzt die Miniatur-»Sternen«-Flotte durch ein weiteres Highlight. Mit seinen hellen klaren Scheinwerfern und dem chromfolienbeprägten Kühlergrill wird das Vorbild mit all seinen unverkennbaren Details wiedergegeben.



### Mercedes-Benz Unimog U 5023

Ein Off-Road Profi geht an den Start! Mit passenderen Werbepublikationen wie »geländegängig«, »robust« und »effizient« kann man dieses Fahrzeug nicht beschreiben. Es ist dafür konzipiert, fast jede Hürde zu nehmen. Das komplett neu entwickelte Modell im Maßstab 1:87 des leistungsstarken Kraftpakets entspricht dem Unimog U 5023. Der Frontbereich wird durch einen sehr breiten Kühlergrill und eine große Motorhaube geprägt. Aufgrund seiner verschiedenen Einsatzmöglichkeiten z.B. in überfluteten Gebieten, hat der U 5023 einen hochgezogenen Ansaugkamin sowie hochgelegte Entlüftungsleitungen. Filigrane hochdetaillierte Außenspiegel und Scheibenwischer in feinsten Spritzgusstechnik sind als separate Teile eingesteckt. Auch ein Blick unter



**NEU**

**51015 Mercedes-Benz Unimog U 5023**  
mit Pritsche und Plane, (metallisch)



Ansicht von hinten

2014

das Modell ist absolut lohnenswert. Hier sind sämtliche Details vom Fahrzeugrahmen bis hin zur Achsaufhängung, den Aggregaten und den seitlichen Aufstiegstritten zu erkennen. Die große Pritsche ist mit einer Plane bespannt, auf der jede noch so klei-

ne Falte und der komplette Umriss des Spiegels zu sehen ist. Grobstollige Reifen mit modelltypischen Felgen sind an der Miniatur natürlich eine absolute Selbstverständlichkeit.



**NEU**

**51001 Mercedes-Benz Unimog U 5023**  
Pritsche »CMD-Collection«, Weiß

2014



**NEU**

**51002 Mercedes-Benz Unimog U 5023**  
Pritsche »CMD-Collection«, Blau

2014



**NEU**

**51007 Mercedes-Benz Unimog U 5023**  
Pritsche »CMD-Collection«, Rot

2014





# EINSATZFAHRZEUGE & LIEFERWAGEN

EMS and service vehicles · Véhicules utilitaires



50410 Traktor Fortschritt ZT 323  
Baustellenfahrzeug

1984



42217 Multicar  
mit Anhänger »Winterdienst«

1991

NEU



42216 Multicar  
»Straßenmeisterei« mit Kehrmaschine

1991



50655 Mercedes-Benz Citan Kombi  
»Straßenmeisterei«

2012

NEU



47976 Iveco Daily  
»Straßenmeisterei«

1996



50915 Mercedes Unimog U 430  
»Straßenmeisterei« mit Mähwerk

2013



50912 Mercedes Unimog 430 Euro 6  
»Winterdienst«

NEU

2013



44972 Anhänger  
»Bauhof«



48486 Piaggio Ape 50  
»Straßenmeisterei«

NEU

2006



50911 Mercedes Unimog U 430  
»Straßenmeisterei«

2013



50608 Mercedes-Benz Citan Kastenwagen  
»Straßenmeisterei«

2013



51110 Mercedes-Benz Vito  
»Straßenmeisterei«

NEU

2014



59934 Anhänger  
»Bauwagen«



 <p><b>40068 Traktor Kramer KL 11</b> mit Schweinetransportkiste</p> <p><b>NEU</b></p> <p>1953</p>	 <p><b>48487 Piaggio Ape 50</b> »Partyservice«</p> <p><b>NEU</b></p> <p>2006</p>	 <p><b>40702 Mercedes-Benz LP 809</b> »Metzgerei« mit Schweinehälften</p> <p><b>NEU</b></p> <p>1992</p>	 <p><b>47729 Ford Model AA</b> »BV Dienst« Aral</p> <p>1931</p>						
 <p><b>40923 DKW 3=6</b> mit Pritsche und Holzgatteraufbau</p> <p><b>NEU</b></p> <p>1956</p>	 <p><b>44929 Anhänger</b> mit Schweinekiste</p> <p><b>NEU</b></p>	 <p><b>59938 Anhänger</b> »Schweineanhänger«</p> <p><b>NEU</b></p>	 <p><b>42302 Peugeot 403</b> »BP«</p> <p>1955</p>	 <p><b>40921 DKW 3=6</b> »BV Aral«</p> <p><b>NEU</b></p> <p>1956</p>					
<p><b>Schlachterei</b> ...so eine Schweinerei!!! Mit saustarken Modellen passend zum Thema »Schlachterei« erscheint eine</p>		<p>kleine Serie mit passenden Modellen u.a. auch aus dem Fuhrpark der Land-Metzgerei Adler Sonntental.</p>		<p>Passende Gebäude und viel Drumherum gibt es im Busch-Modellwelten-Sortiment.</p>					
					 <p><b>41910 Citroen H</b> »BP Renndienst«</p> <p>1958</p>	 <p><b>40913 DKW 3=6</b> »DKW-Kundendienst«</p> <p>1956</p>			
 <p><b>40918 DKW 3=6</b> »BP«</p> <p>1956</p>					 <p><b>41501 Mercedes-Benz 170V</b> »Kugellager Fabrik«</p> <p>1936</p>				
 <p><b>40919 DKW 3=6</b> »Autosattlerei«</p> <p>1956</p>					 <p><b>41503 Mercedes-Benz 170V</b> »Lueg«</p> <p><b>NEU</b></p> <p>1936</p>				



 <p><b>44017 Dodge Power Wagon</b> Abschlepper</p> <p><b>NEU</b></p> <p>1945</p>	 <p><b>49766 Mercedes-Benz GLK-Klasse</b> »Race Cat«</p> <p>2009</p>	 <p><b>50201 Robur LO 2002 A</b> »Bierlieferwagen«</p> <p>1973</p>	 <p><b>47700 Ford Model AA</b> Lieferwagen aus dem Jahre 1931</p> <p>1931</p>	 <p><b>41505 Mercedes-Benz 170V</b> »Zahn der Zeit«</p> <p><b>NEU</b></p> <p>1936</p>
 <p><b>44015 Dodge Power Wagon</b> »Hochspannungstechniker«</p> <p>1945</p>	 <p><b>46161 Smart Fortwo 07</b> »Race Cat«</p> <p>2007</p>	 <p><b>48463 Piaggio Ape 50</b> Grillmobil</p> <p>2006</p>	 <p><b>47724 Ford Model AA</b> »Campbell's Soups«</p> <p>1931</p>	 <p><b>44001 Dodge Power Wagon</b> Farmtruck</p> <p>1945</p>
 <p><b>50605 Mercedes-Benz Citan Kastenwagen</b> »Servicefahrzeug«</p> <p><b>NEU</b></p> <p>2012</p>	 <p><b>47924 Iveco Daily</b> »Welde No. 1«</p> <p>Aufklappbar!</p> <p>1996</p>	 <p><b>48471 Piaggio Ape 50</b> »Bäckerei 2«</p> <p>2006</p>	 <p><b>47725 Ford Model AA</b> »The Times«</p> <p>1931</p>	 <p><b>40915 DKW 3=6</b> Bus</p> <p>1956</p>
 <p><b>44063 Tempo Dreirad Hanseat</b> »Papierfabrik«</p> <p>1935</p>	 <p><b>44941 Ausschankwagen</b> »Welde No. 1«</p> <p>Aufklappbar!</p> <p>1996</p>	 <p><b>48473 Piaggio Ape 50</b> »Fischhandlung«</p> <p>2006</p>	 <p><b>47726 Ford Model AA</b> »The Washington Post«</p> <p>1931</p>	 <p><b>40917 DKW 3=6</b> »Meierei«</p> <p>1956</p>
 <p><b>40703 Mercedes-Benz LP 809</b> »Papierfabrik«</p> <p><b>NEU</b></p> <p>1992</p>	 <p><b>40063 Traktor Kramer KL 11</b> »Früh Kölsch«</p> <p>1953</p>	 <p><b>47926 Iveco Daily</b> »Grill Express«</p> <p><b>NEU</b></p> <p>1996</p>	 <p><b>41906 Citroen H</b> »Feines von Wilma«</p> <p>Ansicht mit offener Klappe</p> <p>1958</p>	 <p><b>41906 Citroen H</b> »Feines von Wilma«</p> <p>1958</p>



 <p><b>NEU</b></p> <p>48281 Chevrolet Pick-up Rot</p>	 <p><b>NEU</b></p> <p>48283 Chevrolet Pick-up Gelb</p>	 <p>41902 Citroën H »Crêpes Mobil«</p> <p>1958</p>	 <p>41908 Citroën H Zeitschriften-Lieferwagen</p> <p>1958</p>	 <p><b>NEU</b></p> <p>41914 Citroën H Möbel-Lieferwagen</p> <p>1958</p>
 <p><b>NEU</b></p> <p>48284 Chevrolet Pick-up Blau</p> <p>1950</p>	 <p><b>NEU</b></p> <p>48234 Chevrolet Pick-up »Butchers«</p> <p>1950</p>	 <p>41903 Citroën H »Café HY«</p> <p>1958</p>	 <p>41909 Citroën HY metallic</p> <p>1958</p>	 <p><b>NEU</b></p> <p>41916 Citroën H »Bridel«</p> <p>1958</p>
 <p>Renault 4 CV 46504 »Picon«</p> <p>1958</p>	 <p>46514 Renault 4 CV »Berget«</p> <p>1958</p>	 <p>41904 Citroën H »Grünländer«</p> <p>1958</p>	 <p><b>NEU</b></p> <p>41911 Citroën H »Martell«</p> <p>1958</p>	 <p>41957 Citroën H »Sultane«</p> <p>1958</p>
 <p>46511 Renault 4 CV »Rustines« mit Anhänger</p> <p>1958</p>	 <p>Renault 4 CV 46515 »Poulain«</p> <p>1958</p>	 <p>41905 Citroën H »Kölln«</p> <p>1958</p>	 <p><b>NEU</b></p> <p>41912 Citroën H »Distillerie«</p> <p>1958</p>	 <p>41958 Citroën H »Abeille«</p> <p>1958</p>
 <p>Renault 4 CV 46512 »Mazda«</p> <p>1958</p>	 <p>46517 Renault 4 CV »La Redoute«</p> <p>1958</p>	 <p>41907 Citroën H Lebensmittel-Lieferwagen</p> <p>1958</p>	 <p>41913 Citroën H »Orange«</p> <p>1958</p>	 <p>48013 Citroën DS19 »Bomo«</p> <p>1955</p>



 <p><b>50215 Robur LO 2002 A</b> »Robur« niedere Pritsche</p> <p>1973</p>	 <p><b>48450 Piaggio Ape 50</b></p> <p>2006</p>	 <p><b>46130 Smart Fortwo 07</b> »Erdbeere«</p> <p>2007</p>	 <p><b>NEU</b></p> <p><b>46210 Smart Fortwo Coupé 2012</b> »BS Energy«, (metallic)</p> <p>2012</p>  <p>Ansicht von der Seite</p>  <p><b>NEU</b></p> <p><b>46211 Smart Fortwo Coupé 2012</b> »Lindt, Goldhase« (metallic)</p> <p>2012</p>	
 <p><b>50223 Robur LO 2002 A</b> »Spielmobil«</p> <p>1973</p>	 <p><b>48478 Piaggio Ape 50</b> »Kleiner Feigling«</p> <p>2006</p>	 <p><b>46131 Smart Fortwo 07</b> »Spargel«</p> <p>2007</p>		
 <p><b>50231 Robur LO 2002 A</b> »Diskomobil«</p> <p>1973</p>	 <p><b>48480 Piaggio Ape 50</b> »Espresso Ambulanz«</p> <p>2006</p>	 <p><b>46154 Smart Fortwo Cabrio</b> »Nudossi« Baujahr 2000</p> <p>2000</p>		
 <p><b>50306 Land Rover Defender</b> »UHU«</p> <p>1983</p>	 <p><b>48481 Piaggio Ape 50</b> »Sizilien«</p> <p>2006</p>	 <p><b>46176 Smart Fortwo Cabrio 07</b> »Kinderzahnärzte«</p> <p>2007</p>	 <p><b>46205 Smart Fortwo 2012</b> »Lindt«, Gold (metallic)</p> <p>2012</p>	 <p><b>42200 Multicar</b> mit Pritsche</p> <p>1991</p>
 <p><b>44622 Chrysler Voyager</b> »Bestattungsinstitut«</p> <p>1990</p>	 <p><b>NEU</b></p> <p><b>48485 Piaggio Ape 50</b> »Bulldog«</p> <p>2006</p>	 <p><b>46163 Smart Fortwo 07</b> »BSR«</p> <p>2007</p>	 <p><b>46160 Smart Fortwo 07</b> »0 Emission«</p> <p>2007</p>	 <p><b>44921 Pferdetransportanhänger</b> »Stapler mieten«</p>





**46901 Auto Union Typ C**  
»Bremgarten/Schweiz 22.8.1937,  
Nuvolari/Rosemeyer«

1936



**47001 Mercedes-Benz Silberpfeil W196**  
»Aintree 16.7.1955, 1. Platz, Stirling Moss«

1936



**48306 Mercedes-Benz SSK**

1928



**40302 BMW 3.5 CSL**  
»Rennwagen Start-Nr. 30«

1975



**9838836 Alfa 147**  
Cup Version 2001

2001



**40307 BMW 3.5 CSL**  
»Rennwagen Start-Nr. 5«

1975



**49815 Mercedes-Benz M-Klasse W164**  
»Royal Racing Team / Follow me«

2005



**9838821 Ford RS200**  
Rallyversion

1986



**43659 Mercedes-Benz C-Klasse T-Modell**  
»Royal Racing Team / Safety Car«

2007

### Chip-Collect-Cars

Aus und vorbei!!!! Die in sich abgeschlossene Sammlerserie von streng limitierten Land Rover Modellen aus der Bergwacht-Collection ist mit Auslieferung der Nr. 12 (»Alpin-Notruf Triestingtal« Art.-Nr. 50391) Ende 2014 zum Abschluss gekommen. Damit wurde nun auch das letzte Puzzle-Teil für das Bild der »Bergwacht Schwarzwald« ausgeliefert – es ist komplett. Alle treuen Sammler haben bereits begonnen, uns die fertigen Puzzles für das 13. kostenlose Modell der »Bergwacht Schwarzwald« einzusenden (Busch GmbH & Co.KG, Kennwort: Chip-Collect-Car, Postfach 12 60, 68502 Viernheim). Da es nur auf diesem Wege erhältlich ist, ist es eine wahre Rarität!!! Ein-sendeschluss ist der 31.03.2015 (ab diesem Zeitpunkt entfällt der Anspruch auf das 13. kostenlose Modell). Haben Sie Ihre »Belohnung« schon angefordert???



Chip Collect Car



**50384 Land Rover Defender**  
Sammel-Edition »Bergwacht«  
Nr. 5 »Bergrettungsdienst Salzburg« (metallic)

1983



**50388 Land Rover Defender**  
Sammel-Edition »Bergwacht«  
Nr. 9 »Bergrettung Sexten«

1983



**50389 Land Rover Defender**  
Sammel-Edition »Bergwacht«  
Nr. 10 »Bergrettung Italien«

NEU

1983



**50391 Land Rover Defender**  
Sammel-Edition »Bergwacht«  
Nr. 12 »Alpin-Notruf Triestingtal«

NEU

1983



**50386 Land Rover Defender**  
Sammel-Edition »Bergwacht«  
Nr. 7 »Bergrettung Tschechien«

1983



**50380 Land Rover Defender**  
Nr. 1 »Bergwacht Hessen«

BEREITS AUSVERKAUFT!



**50382 Land Rover Defender**  
Nr. 3 »Bergrettungsdienst  
Frankreich«



**50390 Land Rover Defender**  
Sammel-Edition »Bergwacht«  
Nr. 11 »Bergrettung Polen«

NEU

1983



**50383 Land Rover Defender**  
Sammel-Edition »Bergwacht«  
Nr. 4 »Höhenrettung Feuerwehr Reutlingen«

1983



**50387 Land Rover Defender**  
Sammel-Edition »Bergwacht«  
Nr. 8 »Bergrettung Botzen Sarntal«

1983



**50381 Land Rover Defender**  
Nr. 2 »Bergrettungsdienst  
Polen«



**50385 Land Rover Defender**  
Nr. 6 »Bergrettung Italien«



 <p><b>40051 Traktor Kramer KL 11</b> mit Bauer und Anhänger mit Schwein, inkl. Schild</p> <p>1953</p>	 <p><b>40058 Traktor Kramer KL 11</b> »Blau«</p> <p>1953</p>	 <p><b>40065 Traktor Kramer KL 11</b> mit Überrollbügel</p> <p>1953</p>	 <p><b>50000 Traktor Porsche Junior K</b> mit Überrollbügel</p> <p>1957</p>	 <p><b>50003 Traktor Porsche Junior K</b> mit Mähbalken</p> <p>1957</p>
 <p><b>50004 Traktor Porsche Junior K</b> mit Überrollbügel</p> <p>1957</p>	 <p><b>50005 Traktor Porsche Junior K</b> Anhänger mit Torfladung</p> <p>1957</p>	 <p><b>50007 Traktor Porsche Junior K</b> mit »Heuwender Bautz-Spinne BS4«</p> <p>1957</p>	 <p><b>50008 Traktor Porsche Junior K</b> Schwarz</p> <p>1957</p>	<p>NEU</p> 
 <p><b>42802 Fortschritt ZT 300</b> »Berliner Verkehrsgesellschaft« 8704 Modell im Maßstab 1:120 TT</p> <p>1964</p>	 <p><b>42807 Fortschritt ZT 300</b> mit Plakatwagen</p> <p>1967</p>	 <p><b>42825 Fortschritt ZT 303</b> »VEB« Energieversorgung mit Anhänger</p> <p>1967</p>		
 <p><b>42809 Traktor Fortschritt ZT 300</b> »VEB«</p> <p>1967</p>	 <p><b>42819 Fortschritt ZT 303</b> mit Heuanhänger</p> <p>1967</p>	 <p><b>42834 Traktor Fortschritt ZT 300</b> »Erdbeer- / Spargelhof«</p> <p>1967</p>		
 <p><b>42812 Fortschritt ZT 303</b> »Stadtwerke Dresden« 8705 Modell im Maßstab 1:120 TT</p> <p>1967</p>	 <p><b>42815 Fortschritt ZT 300</b> »Interflug«</p> <p>1967</p>	 <p><b>42820 Fortschritt/Hangtraktor ZT 305</b></p> <p>1967</p>	 <p><b>42822 Traktor Fortschritt ZT 300</b> »Flickwerk« mit Schneeschieber + Salzstreuer</p> <p>1967</p>	 <p><b>42823 Traktor Fortschritt ZT 305</b> mit Einfachbereifung</p> <p>1967</p>



 <p><b>42829 Traktor Fortschritt ZT 303</b> mit Zwillingssreifen</p> <p>1967</p>	 <p><b>42836 Traktor Fortschritt ZT 300</b> mit Hochsitz</p> <p>1967</p>	 <p><b>42839 Traktor Fortschritt ZT 303D</b> »Goldene Ähre«</p> <p>1967</p>	 <p><b>50234 Robur LO 2002 A</b> »Goldene Ähre«</p> <p>1973</p>	 <p><b>50513 Lada 1500</b> »Goldene Ähre«</p> <p>1973</p>
 <p><b>42833 Traktor Fortschritt ZT 303</b> »Orange«</p> <p>1967</p>	 <p><b>50401 Traktor Fortschritt ZT 323-A</b> mit Winterblech, Sienagrün</p> <p>1984</p>	<p>Im Jahr 1955 (nach Beschluss der SED vom 9. – 12. Juli 1952 / Maßnahme zur Bildung von Genossenschaften) entstand das erste große LPG-Gebäude (Landwirtschaftliche Produktionsgenossenschaft) am Stadtrand von Sonntal-Ost. Das versinnbildlichende Logo entstand nach ganz simplen Gesichtspunkten. Ein Zahnrad als Sinnbild für »Ineinanderzueinander-Sein und die beiden Ähren für das Getreide, das Urwüchsige für das naturnahe Leben auf dem Land. Die staatliche Genossenschaft selbst löste sich zwar nach dem Mauerfall auf, wurde aber durch einen Zusammenschluss der Bauern neu gegründet. Ein Teil des Fuhrparks der ehemaligen Genossenschaft ist im Museum in einem einstigen LPG-Gebäude untergebracht. Diese drei Modelle legen den Grundstein einer wunderschönen Sammel-Edition.</p>		
 <p><b>42837 Traktor Fortschritt ZT 300</b> »Blau/Grau«</p> <p>1967</p>	 <p><b>50402 Traktor Fortschritt ZT 320-A</b> mit Winterblech, Sienagrün</p> <p>1984</p>			
 <p><b>42824 Traktor Fortschritt ZT 303</b> »Graubner Transport«</p> <p>1967</p>	 <p><b>50403 Traktor Fortschritt ZT 323-A</b> »Graubner Transport«</p> <p>1984</p>	 <p><b>50406 Traktor Fortschritt ZT 323-A/M</b> »Melioration«</p> <p>1984</p>	 <p><b>50408 Traktor Fortschritt ZT 323-A</b> mit Winterblech, Rot</p> <p>1984</p>	 <p><b>50414 Traktor Fortschritt ZT 323</b> mit Mähwerk</p> <p>1984</p>
 <p><b>50400 Traktor Fortschritt ZT 303</b> mit Winterblech, Blau</p> <p>1984</p>	 <p><b>50405 Traktor Fortschritt ZT 323</b> »Flughafen Berlin«</p> <p>1984</p>	 <p><b>50407 Traktor Fortschritt ZT 323-A</b> ohne Winterblech, Hellgrün</p> <p>1984</p>	 <p><b>50412 Traktor Fortschritt ZT 323-A</b> mit geöffnetem Dach, Sienagrün</p> <p>1984</p>	 <p><b>50413 Traktor Fortschritt ZT 320-A</b> mit geöffnetem Dach, Sienagrün</p> <p>1984</p>





44974 Landwirtschaftlicher Anhänger mit Mist



59902 Dreschmaschine »Lanz«

1911



44975 Landwirtschaftlicher Anhänger Grün

1958



44976 Landwirtschaftlicher Anhänger Blau

1958



44917 Anhänger mit Plane »Färsenaufzucht«



44977 Landwirtschaftlicher Anhänger Rot

1958



42850 Pflug Fortschritt B200



44922 Anhänger mit Ballonreifen mit Ziegelschutt

1958



59930 Anhänger »Kälberanhänger«



42851 Aufsattel-Beetpflug Fortschritt B200 »Blau«



44930 Heuwagen



42860 Flüssigmisttankanhänger HTS 100.27



59932 Anhänger »Schäferwagen«



59931 Anhänger »Bienenwagen«



50081 Bautz-Spinne BS4 Heuwender »Zahn der Zeit«



44979 Landwirtschaftlicher Anhänger mit Rungen

1958



44973 Anhänger Landwirtschaftlicher Anhänger + Wassertank »Zahn der Zeit«

1958



44978 Landwirtschaftlicher Anhänger mit Wassertank

1958



44923 Wassertankanhänger



44927 Transportanhänger mit Segelflugzeug »Lanz Bulldog«





**ANHÄNGER**  
Trailers · Remorques



59935 Anhänger  
»Küchenwagen«



59936 Anhänger  
»Imbissanhänger«



59937 Anhänger  
»Toilettenwagen«



59933 Anhänger  
»Gartenwagen«



44983 Airstream  
»Imbiss«

1958



**DER CLUB**

# Willkommen im Club!

## Jetzt Mitglied werden!

Profitieren Sie mehrfach von den Vorteilen! Nutzen Sie den direkten Kontakt zu den Herstellern und anderen Modellbauern. Als Mitglied erhalten Sie kostenlos: Hauptkataloge, exklusive Club-Card für z.B.

vergünstigte Eintrittspreise bei Messen und Museen, Club-Zeitschrift MIKRO TICKER, exklusive Modelle, Online-Forum, Newsletter mit den neusten Infos u.v.m.

Online-Forum und Information unter:

[www.mikrolaender.de](http://www.mikrolaender.de)



## Hanomag AL 28 MKW »Wohnwagen«

Robust und zuverlässig!!! Warum sollte man den Hanomag nicht als Wohnwagen umfunktionieren? Das haben sich wohl die Besitzer dieses beweglichen Heims gedacht und sind damit nun in Island unterwegs, was man auf dem seitlichen Aufkleber erkennen kann. Manche verbringen hier ihre Rente und reisen quer über die beschauliche Insel

der Naturliebhaber oder zu Forschungszwecken umher. Das farbharmonische Modell ist ein wunderschönes Stück, das selbst heute noch auf »Aussteiger-Inseln« in verschiedenen Varianten zu finden ist und treu seine Dienste tut.

Dieses Hanomag Modell ist exklusiv nur für MIKRO LÄNDER Club Mitglieder, die Bestellunterlagen werden mit der MIKRO TICKER Aussendung im Frühjahr zugeschickt.

**EINE INITIATIVE VON**







**40163 Mährescher MDW**  
»Erntemeister E514«

Ansicht von hinten mit Hänger

1982

**40169 Mährescher Fortschritt E514**  
»Dauereinsatz« Blau, mit Anhänger



1982

**40165 Mährescher Fortschritt E514**  
»Ernteverband«



1982

**40171 Mährescher Fortschritt E514**  
»Ernteverband«, mit Anhänger



1982

**40166 Mährescher Fortschritt E514**  
»Ernteverband«



1982

**40172 Mährescher Fortschritt E514**  
»Bonhill«



1982

**40167 Mährescher Fortschritt E514**  
Rot mit Hänger



1982

**40173 Mährescher Fortschritt E514**  
»MDW« Hellgrün



1982

**40168 Mährescher Fortschritt E514**  
»Schweiz«



1982

**40180 Anhänger zu Mährescher Fortschritt E514, Blau**



1982

**40181 Anhänger zu Mährescher Fortschritt E514, Grün**



1982

**40182 Anhänger zu Mährescher Fortschritt E514, Rot**



1982





42871 Weimar Mobilbagger T 174-1

1965



42876 Weimar Mobilbagger T174-1  
»ACZ«

1974



42880 Weimar Mobilbagger T174-2 E

1974



42882 Weimar Mobilbagger T 174-1  
»Zahn der Zeit«

1965



42877 Weimar Mobilbagger T174-2  
Sienagrün

1974



42881 Weimar Mobilbagger T174-2  
»Bahnbetriebswerk Hilbersdorf«

1974



42886 Weimar Mobilbagger T174-1  
»Mauerfall«

1965



42879 Weimar Mobilbagger  
»VEB« Energieversorgung mit Kabeltrommel

1974



42885 Weimar Mobilbagger T174-2  
mit Holzgreifer »Papierfabrik«

1974





50214 Robur LO 2002 A  
»Circus Busch« 1973



48475 Piaggio Ape 50  
»Circus Renz« 2006

47922 Iveco Daily  
»Circus Renz« 1996



46203 Smart Fortwo Coupé  
»Merz & Pilini« 2012



50607 Mercedes-Benz Citan Kastenwagen  
»Merz & Pilini« 2012



50913 Mercedes-Benz U 430  
»Merz & Pilini« 2013

NEU



49942 Umzugswagen-Set Nr. 1  
»Eröffnungswagen und Winzergenossenschaft«  
Mercedes-Benz 220 und Tempo Dreirad 1935



40062 Traktor Kramer KL 11  
»Umzugswagen Nr. 5« Pfarrgemeinde 1953



50001 Traktor Porsche Junior K  
»Umzugswagen Nr. 6« Fleischerwagen 1957



40061 Traktor Kramer KL 11  
»Umzugswagen Nr. 2« Bäckerwagen 1953



50002 Traktor Porsche Junior K  
»Umzugswagen Nr. 4« Freiwillige Feuerwehr 1957



42828 Traktor Fortschritt ZT303  
»Umzugswagen Nr. 3« Maurerzunft





95102 W50L BTP (Bautruppfahrzeug)  
»Wohnungsbau«



95108 W 50L Sp (Speditionspritsche)  
»Orwo«



95109 W 50L MK (Möbelkoffer)  
»VEB Möbelkombinat Eisenberg«



95111 IFA W50L Sp (Speditionspritsche)  
»Volan«



95112 IFA W50L Sp (Speditionspritsche)  
»Hungarocamion«



95115 W 50L MK (Möbelkoffer)  
»Möbel und Pianos aus Eisenberg«



95117 IFA W50L MK (Möbelkoffer)  
»Möbel«



95119 IFA W50 MK (Möbel-Koffer)  
»Orwo«



95120 IFA W50 Sp (Speditionspritsche)  
»CSAD«



95125 IFA W50 MK (Möbel-Koffer)  
»VMI«



95126 IFA W50 Sp (Speditionspritsche)  
»Lacufa«



95132 IFA W50 MK (Möbel-Koffer)  
»Hansetrans«



95133 IFA W50 Sp (Speditionspritsche)  
»Handelstransport«



95135 IFA W50 L LF Schankwagen  
»Butchersbar«, in Präsentbox



95136 IFA W50 MK (Möbel-Koffer)  
»Lacufa«



95137 IFA W50 Sp (Speditionspritsche)  
mit Lok »Ziegelei«



95141 IFA W50 MK (Möbel-Koffer)  
»SYS Pur«



95142 IFA W50 Sp (Speditionspritsche)  
»Dachser«



95146 IFA W50 MK (Möbel-Koffer)  
»Volan«





**NEU**



95144 IFA W50 2SK (Zwei-Seiten-Kipper)  
Hellgrün mit dunkelgrauer Pritsche



95202 W 50LA 3SK  
mit T174 -2 »Ziegelei Rotes Banner«



95210 IFA W50LA 3SK + LSR  
mit Schneepflug »Post«



95101 W50L RTGW (Rettungserätewagen)  
»Feuerwehr Erfurt«

**NEU**



95121 IFA W50 TLF (Tanklösch-Fahrzeug)  
»Tschechische Feuerwehr«

**NEU**



95123 IFA W50 TLF (Tanklösch-Fahrzeug)  
mit Bauchbinde

**NEU**



95124 IFA W50 GMK (Ganzmetallkoffer)  
mit Bauchbinde

**NEU**



95131 IFA W50 RTGW  
mit Bauchbinde

**NEU**



95140 IFA W50 LF16 (Löschfahrzeug)  
»Feuerwehr Erfurt«

**NEU**



95143 IFA W50 FP (Pritsche Speditionsfahrerhaus)  
»Feuerwehr«



95007 HW 80 SHA (Schwerhäckselaufbau)  
»Zirkus Probst«



95110 W 50L BTP (Bautruppfahrzeug)  
»Zirkus Probst«



95114 W 50L Sp (Speditionspritsche)  
»Zirkus Probst / Nr. 1«



95205 IFA W50LA SHA (Schwerhäckselaufbau)  
»Zirkus Probst«





NEU



95130 IFA W50 2SK (Zwei-Seiten-Kipper)  
»LPG Roter Oktober«

NEU



95513 IFA L60 2SK (Zwei-Seiten-Kipper)  
»LPG Roter Oktober«

NEU



95511 IFA L60 SHA (Schwerhäckselaufbau)  
»LPG Roter Oktober«

NEU



95518 IFA L60 ETK (Ersatzteil-Koffer)  
»LPG Roter Oktober«

NEU



95013 HW 80.11  
»LPG Roter Oktober«



95215 IFA W50 LA/A  
»Ägypten«

NEU



95220 IFA W50 LA/A  
»Ägypten«



95510 IFA L60 3SK (Drei-Seiten-Kipper)  
»Ägypten«

NEU



95520 IFA L60 ETK (Ersatzteil-Koffer)  
»Ägypten«



95214 IFA W50 LA/A  
»Bereitschaftspolizei«



95216 IFA W50 LA/A  
»Kommandantendienst«

NEU



95217 IFA W50 TLF (Tanklösch-Fahrzeug)  
»NVA«

NEU



95218 IFA W50 LA TLF GMK  
»NVA«

NEU



95219 IFA W50 LA TLF GMK  
»NVA« in Flecktarnung

NEU



95515 IFA L60 2SK (Zwei-Seiten-Kipper)  
»NVA«

NEU



95512 IFA L60 3SK (Drei-Seiten-Kipper)  
»NVA«





95900 W50L Zubehör-Set  
»Niederdruckbereifung«



95901 W50L Zubehör-Set  
»Hochdruckbereifung«



95902 W50L Zubehör-Set  
»Fahrgestell/Spoiler«



*Italienische  
Leckerbissen  
in 1:43*



60056 Piaggio Ape 50  
»DHL«



60001 Piaggio Ape 50  
mit Pritsche, Rot

60002 Piaggio Ape 50  
mit Pritsche, Blau

60003 Piaggio Ape 50  
mit Pritsche, Gelb



60054 Piaggio Ape 50  
»Polizei«, (metallic)

60055 Piaggio Ape 50  
»Feuerwehr«



60050 Piaggio Ape 50  
mit Kastenaufbau, Schwarz

60051 Piaggio Ape 50  
mit Kastenaufbau, Grün

60052 Piaggio Ape 50  
mit Kastenaufbau, Rot



60004 Piaggio Ape 50  
mit Milchkannen. Ladefläche aus Echtholz.

60053 Piaggio Ape 50  
mit Kastenaufbau »THW«



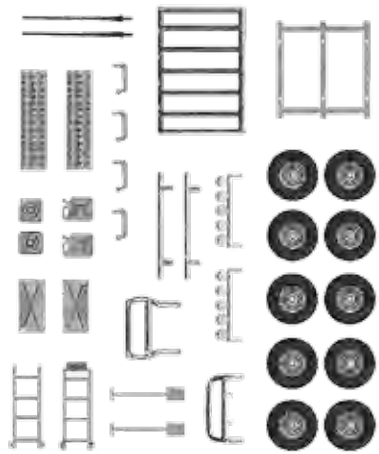

49952 Zubehör Set »Offroad«

49953 Zubehör-Set  
»Landwirtschaft«

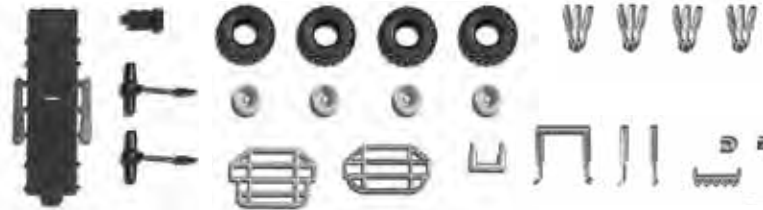

49966 Umbau-Set zur Gestaltung eines Monster-Trucks

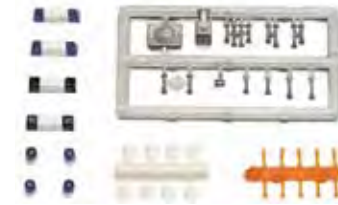

49960 Zubehör-Set  
für europäische Einsatzfahrzeuge  
Blaulichtbalken, Signalhörner, Sirenenkas-  
ten und andere Zurüstteile für moderne  
europäische Einsatzfahrzeuge.



49961 Zubehör-Set I  
für moderne  
amerikanische Ein-  
satzfahrzeuge.  
Signalbalken,  
V-Balken usw. für die  
Ausrüstung moderner  
amerikanischer  
Einsatzfahrzeuge.



49962 Zubehör-Set  
für ältere  
amerikanische Ein-  
satzfahrzeuge.  
Signalbalken,  
Signalhörner und  
andere Zurüstteile  
für amerikanische  
Einsatzfahrzeuge der  
50er Jahre.



49968 Holiday-Set  
Ausgestaltungs-Set für Automodelle rund um das Thema  
»Urlaub« inklusive verschiedener Anhängerkupplungen.

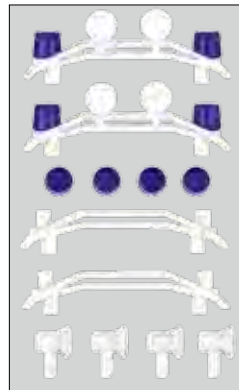

49964 Zubehör-Set  
»Einsatzfahrzeuge Ost«



49969 Ausschnidebogen-Set  
Kennzeichenschilder als Nassschiebilder und Werbeschilder zum Ausschneiden.

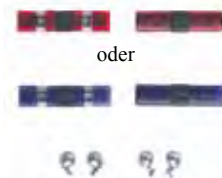

49963 Zubehör-Set II  
für moderne ameri-  
kanische Ein-  
satzfahrzeuge.  
Zwei verschiede-  
ne Signalbalken,  
Suchscheinwerfer und  
Zubehör.

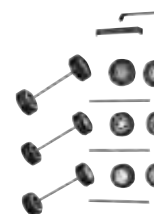

49950 Sportfelgen  
mit Reifen.  
3 verschiedene Sport-  
felgen mit Reifen  
und Achsen für die  
Umrüstung von  
3 PKWs. Außerdem  
2 Spoiler.



49970 Kunststoffbox  
Größe 76 x 30 x 34mm



49971 »Smart«-Tower-Box  
Größe 51 x 25 x 25mm



49973 Präsentationsbox  
Größe 89 x 46 x 53mm



49972 Präsentationsbox  
Größe 103 x 57 x 61mm

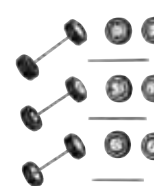

49951 Felgen mit  
Weißwandreifen.  
3 verschiedene  
Felgentypen mit  
Weißwandreifen  
und Achsen für die  
Umrüstung von  
3 PKWs.



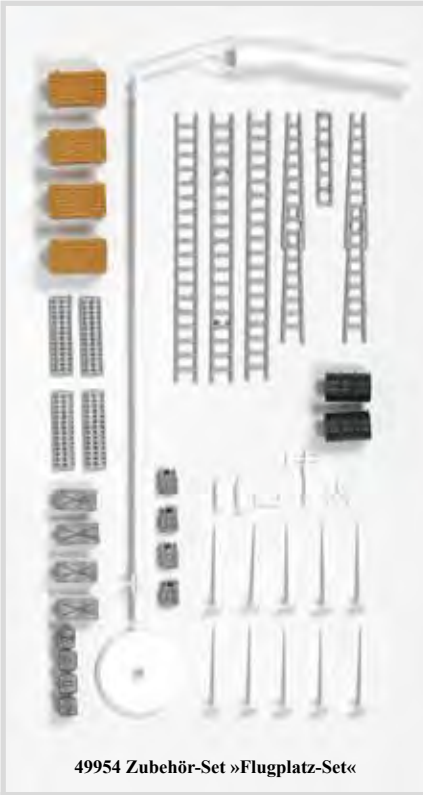

49954 Zubehör-Set »Flugplatz-Set«



49955 Zubehör-Set »Edle Speichenfelgen«

49956 Zubehör-Set »Rennsport«

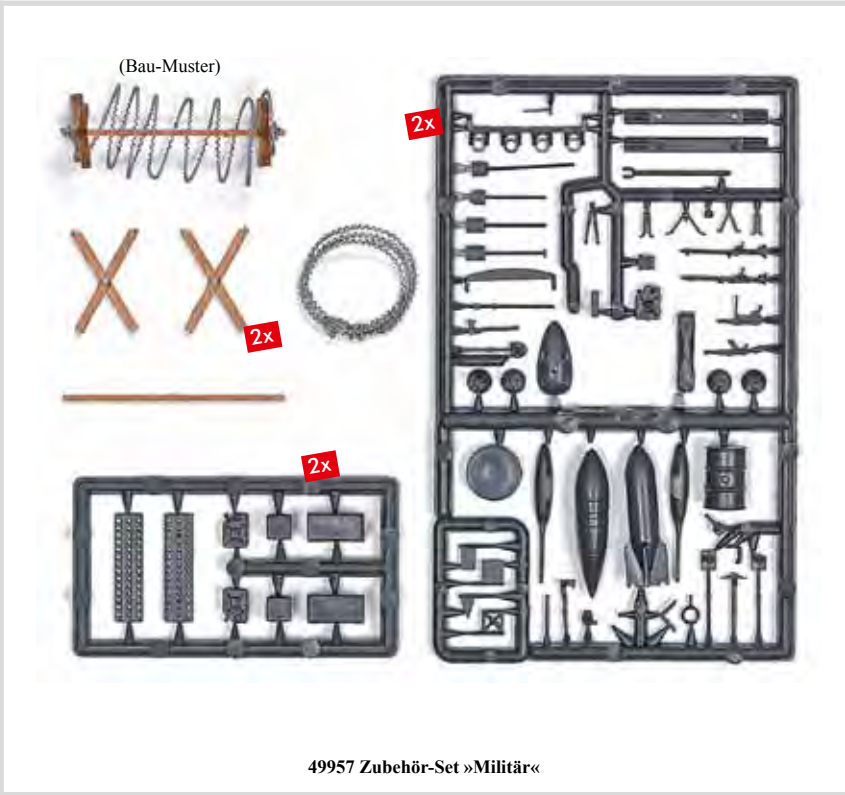

49957 Zubehör-Set »Militär«



49955 Zubehör-Set »Robur«



49958 Zubehör-Set »Feuerwehr-Reifen-Set«



49974 Zubehör-Set »Niederdruckbereifung«

**1690 Modellbau-Reiniger**  
Sagen Sie dem Staub den Kampf an!  
Cyber-Clean® Modellbau-Reiniger entfernt Schmutz und Staub und eliminiert sogar 99,999% der Keime, ohne dabei Rückstände zu hinterlassen. Selbst kleine Zwischenräume, Fugen, Schlitze und unebene Oberflächen sind für die Schmutz absorbierende High-Tech-Reinigungsmasse kein Problem. Schluss mit fuselnden Staubtüchern und unangenehm riechenden Putzklappen. Cyber-Clean® ist der ideale Reiniger für Modelle und Sammlerobjekte jeglicher Art. Reinigen Sie Ihre Schätze auf die sanfte Weise.



**1298 LED-Klemmleuchte mit Lupe**  
Multifunktionale Arbeitshilfe für Handwerk, Hobby und Modellbau. Das superhelle Arbeitslicht und die gleichmäßige Ausleuchtung der Arbeitsfläche wird durch zwei Leuchtdioden und einen speziellen Reflektor erzielt. Durch den Schwannenhals kann die Ausleuchtung optimal für den individuellen Bedarf eingestellt werden. Die praktische Befestigung der Leuchte mit dem Klemmhalter sorgt für freie Hände und unabhängigen Einsatz an den verschiedensten Orten. Die integrierte Lupe mit zweifacher Vergrößerung erlaubt filigranste Arbeiten an dem beleuchteten Objekt. Der unabhängige Betrieb wird durch die kabellose Stromversorgung mit Batterien oder Akkus (3 x Typ »AAA«, nicht enthalten) gewährleistet. Ideal für Wartungsarbeiten an Lokomotiven, Arbeiten unter der Anlagenplatte oder in Tunnels, aber auch für diffizile Bastelarbeiten, im Kosmetikbereich, als Leselampe u. v. m. Länge: ca. 280 mm.





